

# CA ARCserve® Backup for Windows

CA XOsoft™ Integration Guide

r12



This documentation and any related computer software help programs (hereinafter referred to as the "Documentation") is for the end user's informational purposes only and is subject to change or withdrawal by CA at any time.

This Documentation may not be copied, transferred, reproduced, disclosed, modified or duplicated, in whole or in part, without the prior written consent of CA. This Documentation is confidential and proprietary information of CA and protected by the copyright laws of the United States and international treaties.

Notwithstanding the foregoing, licensed users may print a reasonable number of copies of the Documentation for their own internal use, and may make one copy of the related software as reasonably required for back-up and disaster recovery purposes, provided that all CA copyright notices and legends are affixed to each reproduced copy. Only authorized employees, consultants, or agents of the user who are bound by the provisions of the license for the Product are permitted to have access to such copies.

The right to print copies of the Documentation and to make a copy of the related software is limited to the period during which the applicable license for the Product remains in full force and effect. Should the license terminate for any reason, it shall be the user's responsibility to certify in writing to CA that all copies and partial copies of the Documentation have been returned to CA or destroyed.

EXCEPT AS OTHERWISE STATED IN THE APPLICABLE LICENSE AGREEMENT, TO THE EXTENT PERMITTED BY APPLICABLE LAW, CA PROVIDES THIS DOCUMENTATION "AS IS" WITHOUT WARRANTY OF ANY KIND, INCLUDING WITHOUT LIMITATION, ANY IMPLIED WARRANTIES OF MERCHANTABILITY, FITNESS FOR A PARTICULAR PURPOSE OR NONINFRINGEMENT. IN NO EVENT WILL CA BE LIABLE TO THE END USER OR ANY THIRD PARTY FOR ANY LOSS OR DAMAGE, DIRECT OR INDIRECT, FROM THE USE OF THIS DOCUMENTATION, INCLUDING WITHOUT LIMITATION, LOST PROFITS, BUSINESS INTERRUPTION, GOODWILL, OR LOST DATA, EVEN IF CA IS EXPRESSLY ADVISED OF SUCH LOSS OR DAMAGE.

The use of any product referenced in the Documentation is governed by the end user's applicable license agreement.

The manufacturer of this Documentation is CA.

Provided with "Restricted Rights." Use, duplication or disclosure by the United States Government is subject to the restrictions set forth in FAR Sections 12.212, 52.227-14, and 52.227-19(c)(1) - (2) and DFARS Section 252.227-7014(b)(3), as applicable, or their successors.

All trademarks, trade names, service marks, and logos referenced herein belong to their respective companies.

Copyright © 2008 CA. All rights reserved.

## CA Product References

This documentation set references the following CA products:

- Advantage™ Ingres®
- BrightStor® ARCserve® Backup for Laptops and Desktops
- BrightStor® CA-1® Tape Management
- BrightStor® CA-Dynam®/B Backup for VM
- BrightStor® CA-Dynam®/TLMS Tape Management
- BrightStor® CA-Vtape™ Virtual Tape System
- BrightStor® Enterprise Backup
- BrightStor® High Availability
- BrightStor® Storage Resource Manager
- BrightStor® VM:Tape®
- CA ARCserve® Backup Agent for Novell Open Enterprise Server for Linux
- CA ARCserve® Backup Agent for Open Files on NetWare
- CA ARCserve® Backup Agent for Open Files on Windows
- CA ARCserve® Backup Client Agent for FreeBSD
- CA ARCserve® Backup Client Agent for Linux
- CA ARCserve® Backup Client Agent for Mainframe Linux
- CA ARCserve® Backup Client Agent for NetWare
- CA ARCserve® Backup Client Agent for UNIX
- CA ARCserve® Backup Client Agent for Windows
- CA ARCserve® Backup Enterprise Option for AS/400
- CA ARCserve® Backup Enterprise Option for Open VMS
- CA ARCserve® Backup for Microsoft Essential Business Server
- CA ARCserve® Backup for Windows
- CA ARCserve® Backup for Windows Agent for IBM Informix
- CA ARCserve® Backup for Windows Agent for Lotus Domino
- CA ARCserve® Backup for Windows Agent for Microsoft Data Protection Manager
- CA ARCserve® Backup for Windows Agent for Microsoft Exchange
- CA ARCserve® Backup for Windows Agent for Microsoft SharePoint

- CA ARCserve® Backup for Windows Agent for Microsoft SQL Server
- CA ARCserve® Backup for Windows Agent for Oracle
- CA ARCserve® Backup for Windows Agent for Sybase
- CA ARCserve® Backup for Windows Agent for VMware
- CA ARCserve® Backup for Windows Disaster Recovery Option
- CA ARCserve® Backup for Windows Disk to Disk to Tape Option
- CA ARCserve® Backup for Windows Enterprise Module
- CA ARCserve® Backup for Windows Enterprise Option for IBM 3494
- CA ARCserve® Backup for Windows Enterprise Option for SAP R/3 for Oracle
- CA ARCserve® Backup for Windows Enterprise Option for StorageTek ACSLS
- CA ARCserve® Backup for Windows Image Option
- CA ARCserve® Backup for Windows Microsoft Volume Shadow Copy Service
- CA ARCserve® Backup for Windows NDMP NAS Option
- CA ARCserve® Backup for Windows Serverless Backup Option
- CA ARCserve® Backup for Windows Storage Area Network (SAN) Option
- CA ARCserve® Backup for Windows Tape Library Option
- CA XOSoft™ Assured Recovery™
- CA XOSoft™
- Common Services™
- eTrust® Antivirus
- eTrust® Firewall
- Unicenter® Network and Systems Management
- Unicenter® Software Delivery
- Unicenter® VM: Operator®

## Contact Technical Support

For online technical assistance and a complete list of locations, primary service hours, and telephone numbers, contact Technical Support at <http://ca.com/support>.

# Contents

---

<b>Chapter 1: Integrating CA XOssoft with CA ARCserve Backup</b>	<b>7</b>
Introduction .....	7
CA ARCserve Backup .....	8
CA XOssoft .....	9
CA ARCserve Backup and CA XOssoft Integration .....	10
Capabilities and Benefits .....	11
Remote Branch Offices and Central Data Centers .....	12
Integration Terms and Definitions .....	13
How the Integrated Backup Process Works .....	17
Scenario Creation .....	18
Job Creation .....	18
Job Execution .....	19
How the Integrated Restore Process Works .....	20
<b>Chapter 2: Installing and Configuring CA XOssoft with CA ARCserve Backup</b>	<b>23</b>
How to Install CA ARCserve Backup and CA XOssoft .....	23
Integration Configurations .....	24
Configuration with a Stand-alone ARCserve Server .....	25
Configuration with a CA ARCserve Backup Server Installed on a Replica Server .....	26
Remote Branch Office (RBO) Configurations .....	27
RBO Configuration Example 1 .....	28
RBO Configuration Example 2 .....	29
RBO Configuration Example 3 .....	30
<b>Chapter 3: Performing Integrated Backup Jobs</b>	<b>31</b>
Integrated Backup Jobs .....	31
Create a CA XOssoft Scenario .....	31
Run a CA XOssoft Scenario .....	36
Create and Run a Backup Job .....	38
<b>Chapter 4: Performing Integrated Restore Jobs</b>	<b>45</b>
Integrated Restore Jobs .....	45
Restore Using CA XOssoft Failover .....	46
Restore Using CA XOssoft Data Rewind .....	46
Restore Using CA ARCserve Backup .....	47

---

Set CA XOssoft-specific Global Restore Option .....	48
Restore by Session.....	48
Restore by Tree.....	55
Restore by Query .....	58
Restore MS Exchange Scenario to Master Machine .....	60
<b>Chapter 5: Monitoring Backup and Replication Jobs</b>	<b>61</b>
Integrated Job Monitoring .....	61
Monitor Job Status Using CA ARCserve Backup .....	61
Job Queue Monitoring .....	62
Activity Log Monitoring .....	62
Monitor Job Status Using CA XOssoft.....	63
Alert Notification.....	66
CA ARCserve Backup Alerts .....	67
CA XOssoft Alerts .....	68
Report Generation .....	68
CA ARCserve Backup Reports .....	69
CA XOssoft Reports .....	69
<b>Chapter 6: Troubleshooting</b>	<b>71</b>
Integrated Troubleshooting .....	71
Error and Warning Messages .....	71
Integration Messages .....	72
<b>Index</b>	<b>85</b>

# Chapter 1: Integrating CA XOsoft with CA ARCserve Backup

---

This section contains the following topics:

[Introduction](#) (see page 7)

[CA ARCserve Backup](#) (see page 8)

[CA XOsoft](#) (see page 9)

[CA ARCserve Backup and CA XOsoft Integration](#) (see page 10)

[Capabilities and Benefits](#) (see page 11)

[Remote Branch Offices and Central Data Centers](#) (see page 12)

[Integration Terms and Definitions](#) (see page 13)

[How the Integrated Backup Process Works](#) (see page 17)

[How the Integrated Restore Process Works](#) (see page 20)

## Introduction

CA ARCserve Backup provides you with high-performance disk-to-disk (D2D), disk-to-tape (D2T), disk-to-disk-to-tape (D2D2T), backup encryption and integrated antivirus protection, multiplexing, and snapshot backup and recovery capabilities. The addition of CA XOsoft complements these capabilities by adding continuous data protection, replication, and automated application failover. Together they provide a complete, 24-hour a day, 7-day a week integrated solution for recovery management, enabling you to better meet evolving compliance, business continuity, and disaster recovery objectives while saving time and resources.

## CA ARCserve Backup

CA ARCserve Backup provides a complete, flexible, and integrated storage and recovery management solution for distributed and multiplatform environments. This application can back up and restore data from all the machines on your network (including machines running Windows, UNIX, NetWare, and Linux) using optional client agents. CA ARCserve Backup also provides media and device management capabilities.

CA ARCserve Backup offers control from one management console and can support small-scale and large-scale enterprise environments consisting of one machine or many, across different platforms and organizations.

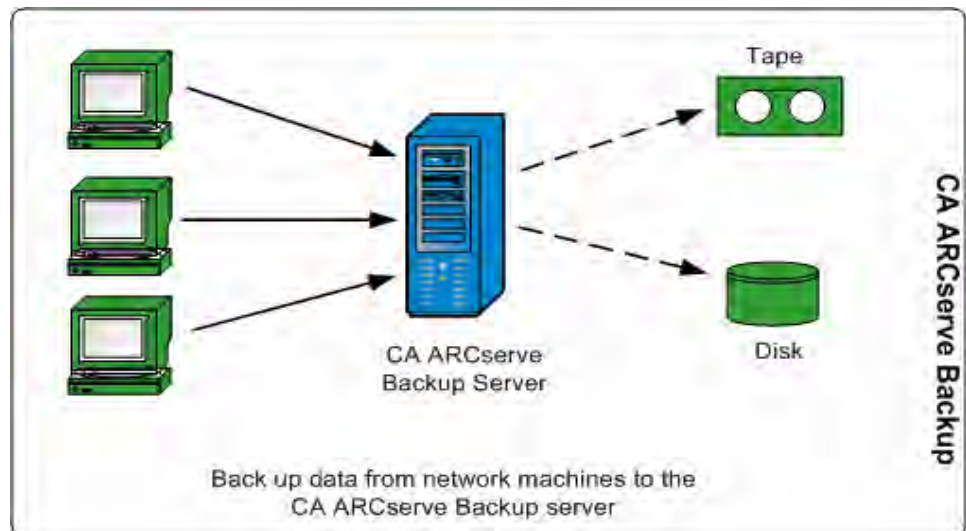



## CA XOssoft

CA XOssoft is a data protection solution that uses asynchronous real-time replication to provide disaster recovery capabilities. This host-based software provides continuous data replication that transfers changes to application data as they occur to a standby replica server located locally or over the Wide Area Network (WAN). Continuous data replication ensures that the most recent data is always available for restoring purposes. Continuous data protection is based on Data Rewind technology for recovery from data corrupted by viruses, user error, or application error.

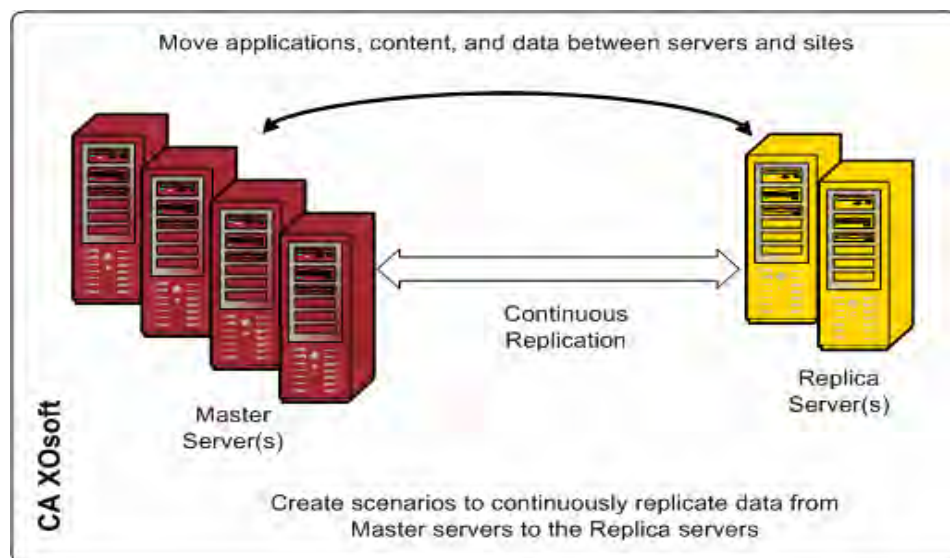

You can also improve your data protection capabilities by adding application monitoring and fully automated failover and failback. These capabilities are provided by CA XOssoftHA, which is a high-availability solution for true continuous application availability.

CA XOssoftHA offers a superset of the capabilities of CA XOssoft. In particular, CA XOssoftHA adds the capability for push-button or automatic failover of clients from the production Master server to a secondary Replica server, without any need to reconfigure clients, as well as the ability to automatically monitor the status of the production server and the applications running on it. After the Master server is restored to its original state, CA XOssoftHA lets an IT administrator reinstate the Master server with the push of a button, automatically failing back from the Replica server with no loss of data or application availability.

## CA ARCserve Backup and CA XOssoft Integration

The integration between CA ARCserve Backup and CA XOssoft provides the dual benefit of continuous data protection and backup of this protected data. Through this integration, CA XOssoft continues to provide real-time, continuous data replication from the Master server (production server) to the Replica server, while CA ARCserve Backup then backs up this replicated data from the Replica server to the CA ARCserve Backup ARCserve Backup server for archiving and compliance. By performing the backup operation from the Replica server, no backup window is required and the impact on the Master server is minimized, enabling the Master server to continue working without any performance degradation. In addition, you can recover the backed-up data to the Master server or to the Replica server using CA ARCserve Backup.

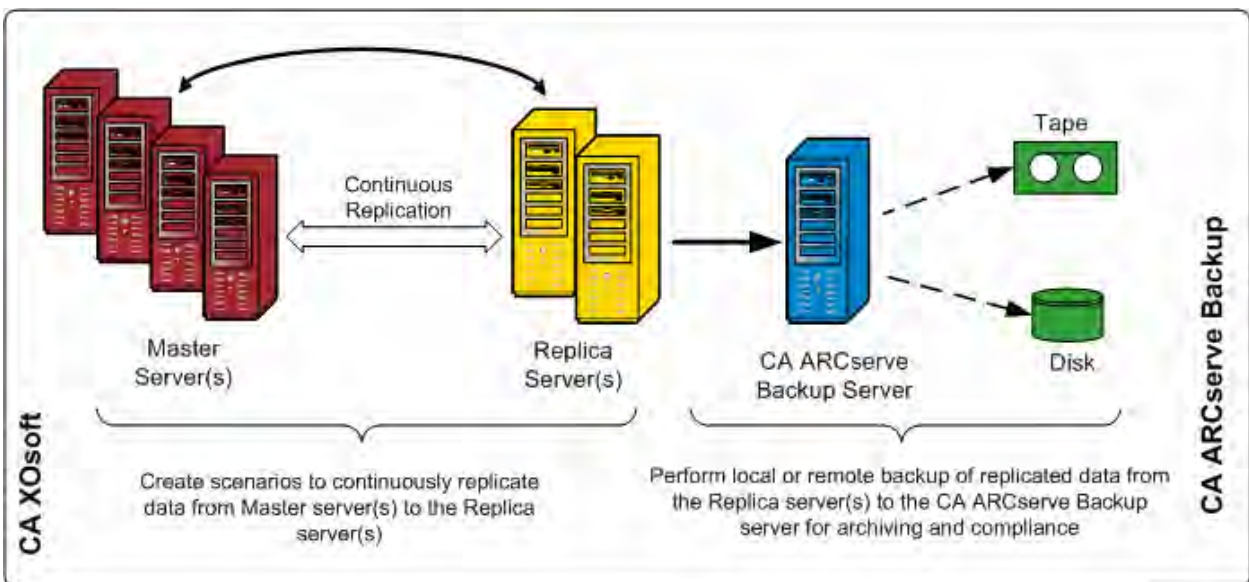

## Capabilities and Benefits

The integration between CA ARCserve Backup and CA XOsoft lets you use replication and continuous protection (using CA XOsoft) and backup (using CA ARCserve Backup) for archiving and compliance.

The integration provides the following core capabilities and benefits:

- Use of the familiar CA ARCserve Backup interface for backup job configuration, scheduling, and management.
- High-performance D2D, D2T, and D2D2T backup and snapshots.
- Backup encryption and integrated antivirus protection.
- Built-in device and media management.
- Real-time, continuous replication of files and data as they change to ensure that the most recent data is always available for restore or recovery.
- Backups are done from the Replica server, which minimizes the impact on the Master server and provides an unlimited backup window.
- Multiple recovery options as follows:
  - Recovery through CA XOsoft using Failover. Recovery capability of an application to a standby server at another location and push-button failback of the application once the production server is restored.
  - Recovery through CA XOsoft using Data Rewind. Recovery capability to rewind to any previous point in time (rewind points) to recover from corrupted data, which provides continuous data protection (CDP).
  - Recovery through CA ARCserve Backup. Recovery capability from tape or other traditional backup media.
- Real-time consolidation of data from multiple remote branch offices (RBOs) to a central data center (CDC), which provides centralized backup and data consolidation. You can use the replica residing in the central data center to perform centralized backup and reduce the need for IT support at every location.
- Assured Recovery capability to provide nondisruptive, fully automated, in-depth testing of the disaster recovery replica server. This allows recoverability testing of the application on the Replica server without any disruption to the Master server, to the replication process, or to the automated failover protection mechanisms that are in place in case of a disaster.

## Remote Branch Offices and Central Data Centers

CA ARCserve Backup together with CA XOSoft lets you create backup replicas of remote branch office (RBO) servers at a central data center (CDC). The backup replica servers located at a CDC provide better disaster recovery and continuous application availability for your branch office servers, as well as centralized and consolidated backups of multiple branch offices at a single facility. This consolidation of backups of remote branch offices significantly reduces the need for competent and sophisticated IT support at every location. Installing and maintaining multiple servers, storage devices, and applications in many different locations can be expensive. In addition, the backup replica servers at a CDC also reduce the security risk associated with tape transport and offsets tape media and handling costs.

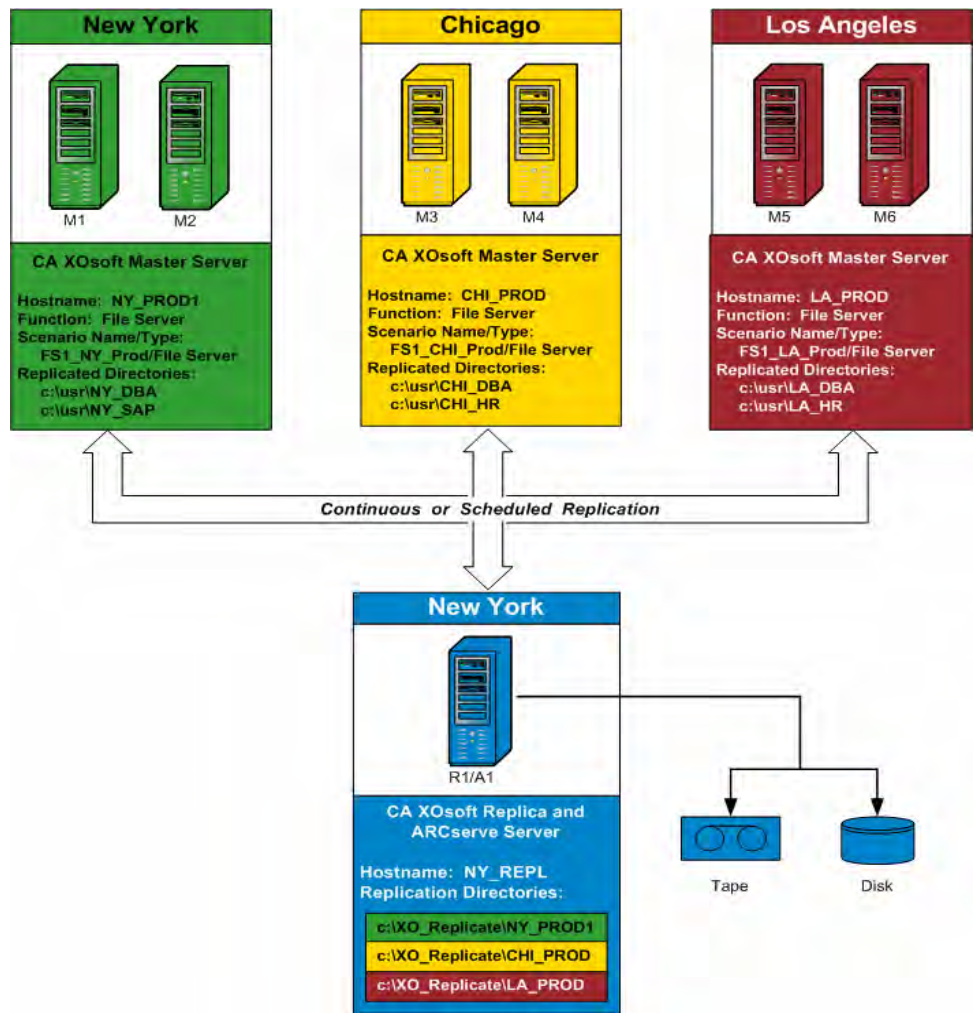

## Integration Terms and Definitions

Before you can understand the details of the integration between CA ARCserve Backup and CA XOsoft, you must be familiar with some of the terms and definitions used by each product.

The integration uses the following terms and definitions:

### Scenario

A CA XOsoft scenario is the fundamental basis for managing the operation of the system. A CA XOsoft scenario always includes at least one Master server and one Replica server. In addition, multiple independent scenarios can run on a single server.

A scenario is a structure that describes the following:

- What applications and data are to be protected
- Where they are located (that is, the Master server and source directories)
- Where the data is to be replicated (the Replica servers and target directories on them)
- Whether and how automated failover and testing should take place

**Note:** CA ARCserve Backup supports File Server, MS Exchange, and SQL Server scenarios only.

### Master Server

The Master server is the active or production server that lets you actively change (read and write) data. Any changes made at any given time on the Master server are captured continuously in real time and transferred (or replicated) to one or more of the associated Replica servers so that all the Replica servers contain an exact copy of the data on the Master server at all times.

### Replica Server

The Replica server is the passive server. This is the server from which data cannot be changed (read only) in any way except through changes replicated from the Master server. There can be multiple Replica servers associated with a single Master server. When synchronizing the replicated data with the Master server, the data between the servers is compared and only the changes made to the Master server are sent to the Replica servers, which minimizes WAN traffic.

### **Continuous Data Protection (CDP)**

Continuous data protection (CDP) is the ability to recover data not just to certain isolated previous states captured, for example, in a daily or weekly backup or snapshot, but to recover the data back to any point in time. That way, whenever a virus occurs, you can recover to a point just minutes before the virus occurred with essentially zero data loss and a very fast recovery time.

### **Failover**

Failover is a feature that detects when the protected application on the Master server fails and switches (either automatically or manually activated) to a designated Replica server with essentially zero loss of data and time. If a Master server fails or must be shut down for maintenance, a synchronized replica (locally or in a remote location) will instantly and automatically take its place.

### **Data Rewind**

Data rewind is a recovery method that allows rewinding files to a point in time (rewind point) before they were corrupted. This built-in rewind technology occurs on the Replica server and any "data rewinding" to a previous state can be performed on the Replica server only.

### **Rewind Point**

A rewind point is a checkpoint in the Rewind log marking an event or operation. The actual information stored includes the operation that will undo the event in case the rewind point is activated. Data recovery uses these rewind points or bookmarks in the Rewind log to reset the current data back to a previous state.

### **Assured Recovery**

Assured Recovery lets you perform a real test of your disaster recovery server by actually running the application, including modifying data, without impacting your production environment or your previously replicated data.

Using Assured Recovery, you can perform transparent, nondisruptive testing of a replicated data snapshot to start up application services and perform all operations necessary to verify the integrity of the data on the Replica server. Assured Recovery provides this functionality without ever leaving your production systems vulnerable during testing, without disrupting production application availability in any way, and without having to resynchronize the data after testing is complete.

### **Suspend Mode**

The Suspend mode temporarily stops delivering changes to the suspended Replica server. Changes will continue to be recorded in a spool until replication is resumed so that resynchronization is not required. After replication is resumed, the accumulated changes are then transferred and applied without any need to perform a full resynchronization data.

When you back up a scenario with Assured Recovery configured, the backup is application-consistent and requires no application recovery after restore. However, when you back up a scenario with the Suspend mode enabled (no Assured Recovery configured), the backup may require application recovery after restore, depending upon the state of the application at the time of the backup.

### **Synchronization**

Synchronization is the process of bringing the data on the Replica server in sync with the data on the Master server. To properly synchronize the Master server and the Replica server, their two file structures are compared to determine what content (files and folders) on the Master server is missing or is different from that on the Replica server. The levels of synchronization are as follows:

- File-level synchronization involves replicating an entire file when a change occurs. This process, which is used for smaller files, copies the entire set of data and sends it to the Replica server (if no part of it exists on the Replica server).
- Block-level synchronization involves determining what has changed and sending only the changes to the Replica server (to minimize the bandwidth and time required). This process is used for replicating large data sets such as databases.

### **Replication**

Replication is a process that maintains identical copies of files and databases by real-time capture of byte-level changes in files on the Master server. These captured changes are asynchronously transmitted to the Replica servers. Because replication continuously updates the source data to another machine, a Replica server always contains the same data as in the Master server. To avoid attempting to restore files that are in use, the application needs to be not running (offline).

## **Entity**

Defines the granular level of detail for a CA XOssoft scenario for backup and restore purposes. The level of granularity for an entity depends on the type of scenario.

### **File Server Entity**

For a File Server scenario, an entity represents all of the files and directories belonging to the same volume on a Master server.

For example, on a Master server the contents of the C: drive would constitute one entity, while the contents of the D: drive would be a separate entity.

### **SQL Server Entity**

For a SQL Server scenario, an entity represents a SQL database.

For example, on a Master server the contents of the Company A Employees database would constitute one entity, while the contents of the Company B Employees database would be a separate entity.

### **MS Exchange Entity**

For an MS Exchange scenario, an entity represents an MS Exchange Storage Group. The entity name is the MS Exchange Storage Group name.



## How the Integrated Backup Process Works

The backup process will back up everything that is part of a scenario. The backup job will create a session for each entity that constitutes a scenario. The supported scenarios are SQL Server, MS Exchange, and File Server.

The integrated backup process for CA ARCserve Backup and CA XOsoft consists of the following three basic functions:

- Scenario Creation
- Job Creation
- Job Execution

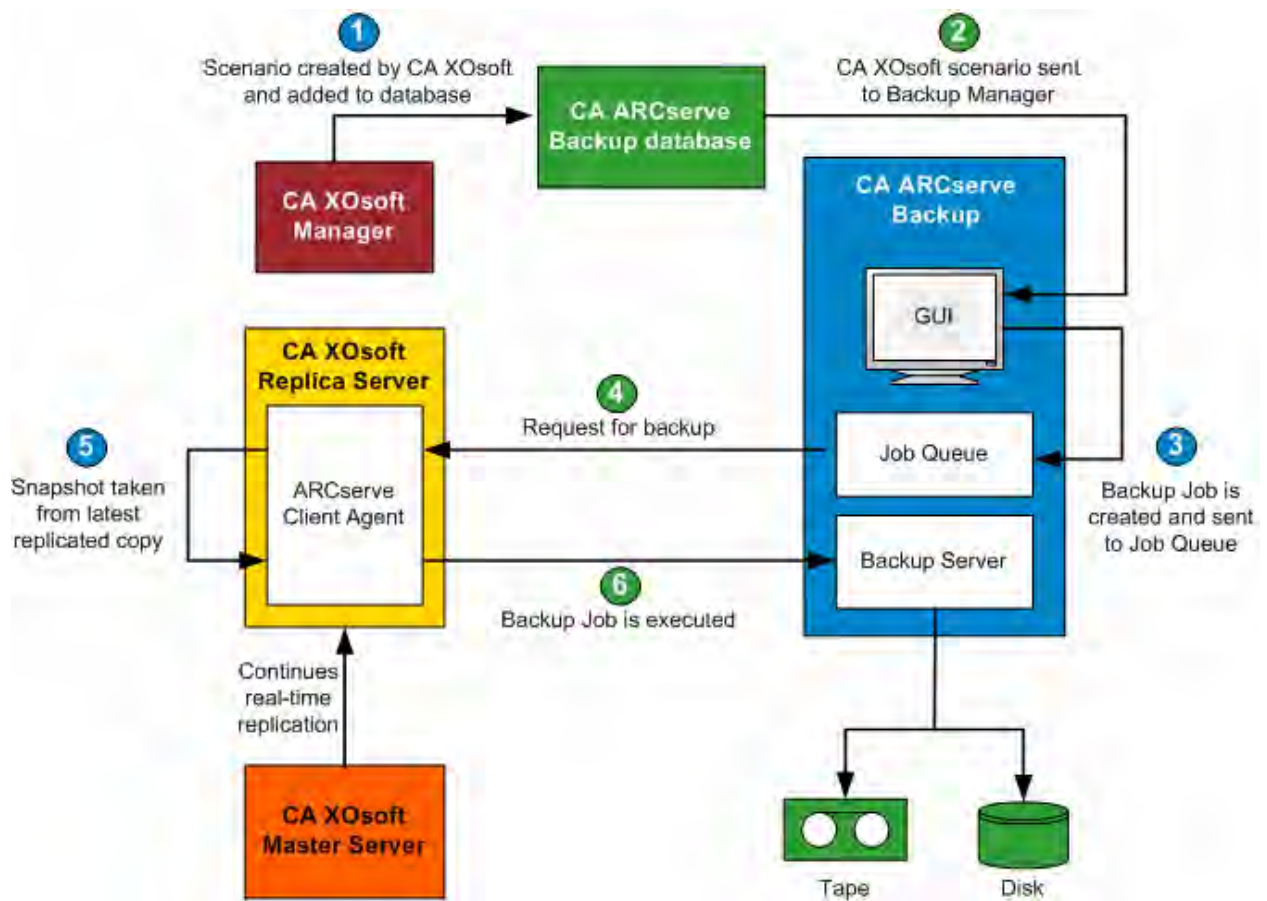

## Scenario Creation

From the CA XOssoft Manager, a scenario is created and the related information is inserted into the CA ARCserve Backup database. For an existing scenario, the related information can be inserted into CA ARCserve Backup database by using the Update ARCServe Backup Server option, which is accessible from the Tools menu of the CA XOssoft Manager. CA ARCserve Backup then queries the database, becomes aware that the scenario exists, and presents the scenario to the user through the Backup Manager GUI. The CA XOssoft scenarios are listed in the source tab of the Backup Manager. When a scenario is selected from the Backup Manager, some corresponding properties are displayed to provide additional information about the selected scenario. These displayed properties include Scenario Name, Scenario Type, and other relevant information about the Master server and Replica servers.

**Note:** A CA XOssoft scenario always includes at least one Master server and one Replica server. In addition, multiple independent scenarios can run on a single server.

You can remove a scenario from the CA ARCserve Backup database by using the Delete Machine/Object option, which is accessible from the properties pane of the Backup Manager GUI. Using Delete Machine/Object removes the scenario from the CA ARCserve Backup database only and not from the CA XOssoft Manager.

## Job Creation

From CA ARCserve Backup, a backup job is created with the user specifying the source, destination, and any other typical backup options. When you attempt to submit a backup job, you will be prompted to provide two sets of security credentials (user name and password). One set of credentials allows the CA ARCserve Backup server to access and communicate with the agent on the Replica server and the other set of credentials allows CA ARCserve Backup to log in to the Master server to prepare for the backup. After the required security credentials are entered, the backup job is submitted to the job queue to be executed at the scheduled time.

## Job Execution

At the scheduled time, CA ARCserve Backup connects to the agent running on the Replica server and asks CA XOssoft to create snapshots of the volumes that are hosting the replicated data for the scenario being backed up. When the request is received, the continuous real-time replication of the scenario is temporarily suspended to facilitate the creation of the snapshot. After the snapshot is created, the Replica server resumes performing real-time replication and the agent running on the Replica server proceeds to perform the backup from the snapshot. You can install the CA ARCserve Backup server on the Replica server or as a separate dedicated server.

For SQL Server and Exchange scenarios, when the backup is complete, the snapshot is preserved and removed only if the maximum number of retained snapshots is reached. By default, CA XOssoft creates and preserves 10 snapshots and then begins replacing the oldest snapshots with newer ones. You can change the setting for the number of snapshots preserved using the Number of Snapshots Set To Keep property on the CA XOssoft Manager.

**Note:** For more information on setting the number of snapshots to be kept, see the *CA XOssoft User Guide*.

For File Server scenarios, when the backup is complete, the snapshot is preserved and not removed at all.

When you back up a scenario with Assured Recovery configured, the backup is application-consistent and requires no application recovery after restore. When you back up a scenario with Suspend enabled (no Assured Recovery configured), the backup may require application recovery after restore, depending upon the state of the application at the time of the backup.

Performing the backup on the Replica server allows the Master server to continue working without any interruptions or performance degradation. In addition, all backup catalog information is recorded as if the backup was performed on the Master server, ensuring that the restore view of the data will always be the same as if the backup was taken directly from the Master server. You can recover the backed-up data to the Master server or to the Replica server using CA ARCserve Backup.

In addition, for multistreaming backup jobs, each CA XOssoft scenario is backed-up as a child job. If one node contains multiple scenarios, the master job will split them so that each child job will back up one scenario.

## How the Integrated Restore Process Works

The restore process will recover data that was replicated from the Master server and then backed up using CA ARCserve Backup. For SQL Server scenarios and MS Exchange scenarios, the restore process supports only full scenario restores. For File Server scenarios, the restore process supports either full scenario restores or granular restores of files, directories, and volumes.

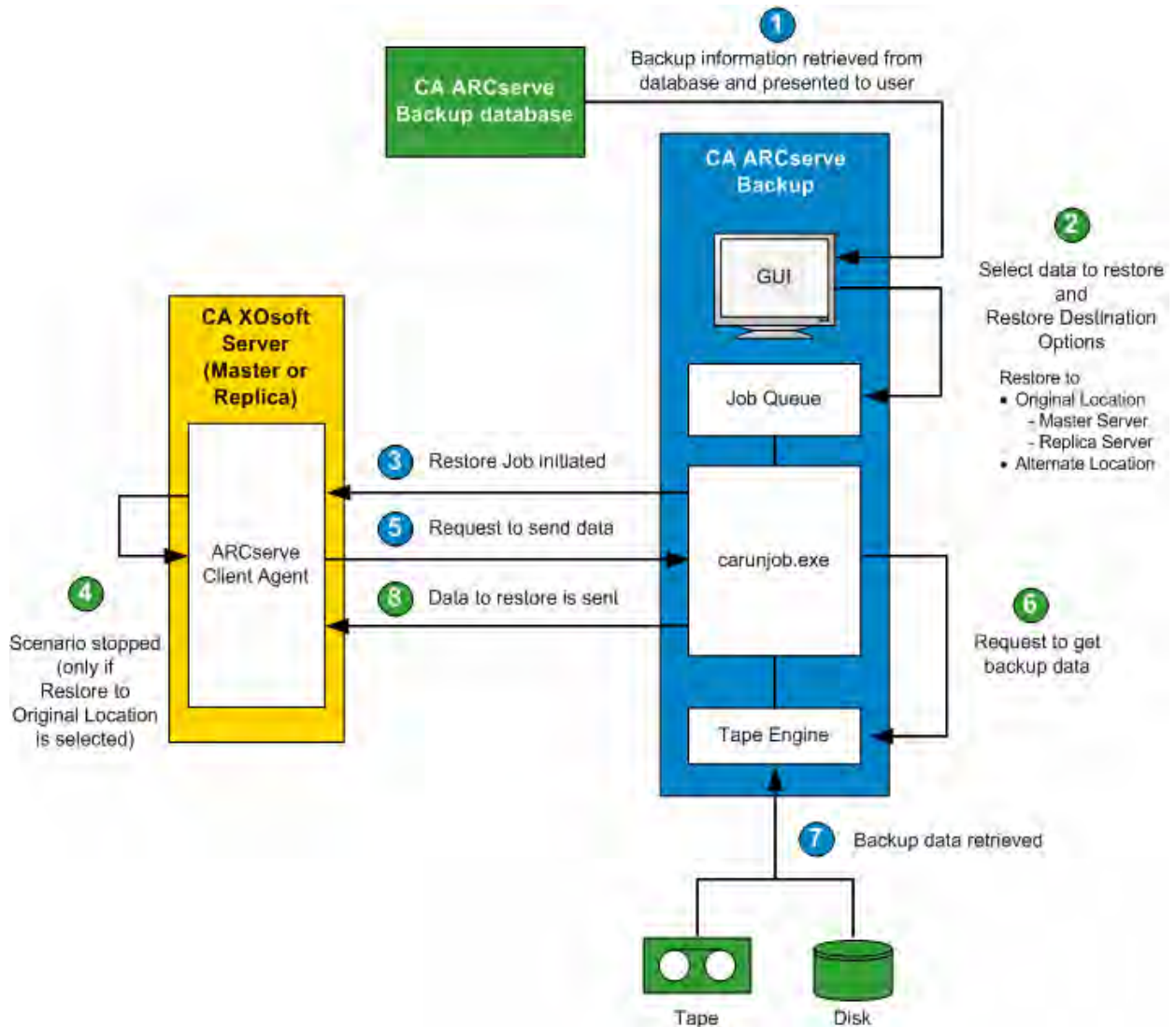

From CA ARCserve Backup, a list of machines that were backed up is retrieved from the database and displayed through the source tab of the Restore Manager GUI. When you select a source from the Restore Manager, some corresponding properties are also displayed to provide additional information about the selected source. After you select a source, you must also select the destination for the restore. The available destination options are to restore the data to its original location or to an alternate location. If you choose the restore to the original location option (default), you will then have to select whether to restore to a Master server or a Replica server for that location. If you do not choose the restore to original location option, you must browse to locate the alternate location for the destination.

When restoring to a Replica server, ensure that the corresponding application is not running to avoid attempting to restore files that are currently in use. When restoring to the Master server, ensure that the CA ARCserve Backup Client Agent is installed and running.

For SQL Server and MS Exchange, if the corresponding application is running and you restore a CA XOsoft scenario to the original location, the restored files are temporarily created with a .TMP extension. After the restore job is successful, you are prompted to reboot the server to overwrite and replace the existing active files. When the server is rebooted, the restored files are merged into the original database. If the corresponding application is not running, temporary files will not be created during the restore to original location process and you will not need to reboot the server.

Rebooting a SQL Server installed on a cluster environment is not feasible, so you must stop the application resource before performing a restore to the original location.

When a restore job is submitted, you are prompted to provide security credentials (user name and password) based on the following options:

- If you selected to restore to the original location, depending on the restore option specified, you must provide either one set of credentials to allow CA ARCserve Backup to communicate with the agent on the Master server (restore to master) or two sets of credentials to communicate with both the Master server and Replica server (restore to replica).
- If you selected to restore to an alternate location, you must provide only one set of credentials to login to the agent on the machine where the restore will be performed.

After you enter the required security credentials, the restore job is submitted to the job queue for execution at the scheduled time.

At the scheduled time, CA ARCserve Backup connects to the agent running on the CA XOssoft server (master or replica, as specified) to initiate the request for data. If you selected the restore to original location option, the continuous replication of the scenario is temporarily suspended before the agent requests the data. Suspending the scenario replication helps ensure data consistency between the Master server and the Replica server. The data on the Master server could be different from the restored data on the Replica server and possibly corrupted. In this case, if the continuous replication process was not suspended, the newly restored data on the Replica server would then be overwritten with the corrupted data from the Master server. If the scenario replication cannot be stopped, the restore job will fail. If necessary, you can select a Restore Manager Global Option to continue the restore job even when the scenario cannot be stopped.

When the agent running on the CA XOssoft server contacts CA ARCserve Backup and requests the data to be sent, the data is retrieved from wherever it was stored (tape or disk) and sent to the specified destination. This process of requesting and sending data is repeated until all the data from the backup is restored. After the restoration is complete, you can restore the data on the Replica server back to the Master server.

# Chapter 2: Installing and Configuring CA XOsoft with CA ARCserve Backup

---

This section contains the following topics:

[How to Install CA ARCserve Backup and CA XOsoft](#) (see page 23)

[Integration Configurations](#) (see page 24)

[Remote Branch Office \(RBO\) Configurations](#) (see page 27)

## How to Install CA ARCserve Backup and CA XOsoft

The following process for installing CA ARCserve Backup and CA XOsoft does not change for the integrated products:

- Perform the usual CA ARCserve Backup installation on the server designated as the CA ARCserve Backup server.  
**Note:** For more information about installing CA ARCserve Backup, see the *CA ARCserve Backup Implementation Guide*.
- Perform the usual CA XOsoft installation on the servers designated as the Master server and Replica server.

To perform backups the following configurations must exist:

- The Replica server must be a Windows 2003 server.
- The Master server must be a Windows server.

**Note:** For more information about installing CA XOsoft, see the *CA XOsoft User Guide*.

## Integration Configurations

You can choose two integration setups, depending on where the CA ARCserve Backup server is installed. One setup configuration involves installing the CA ARCserve Backup server on the Replica server, while the other setup configuration involves having the CA ARCserve Backup server as a separate stand-alone server.

The following chart lists the supported configuration versions for integration between CA ARCserve Backup and CA XOssoft:

<b>CA ARCserve Backup</b>	<b>CA XOssoft</b>	<b>Integration Supported</b>
r12	r12	Yes
r12	v4	Yes
r11.5 SP3	r12	No
r11.5 SP3	v4	Yes

In addition, you need to decide whether or not you will install the CA ARCserve Backup Client Agent on the Master server.

The benefits of installing the Client Agent on the Master server are as follows:

- Direct restores from the CA ARCserve Backup server to the Master server.  
If the Client Agent is not installed on the Master server, you have to restore the Replica server and then perform a CA XOssoft "reverse replication" (from Replica to Master) to ensure that the Master server is fully up-to-date when you switch back to it.
- Bare-metal recovery, which allows the Master server to be rebuilt from scratch, including complete recovery of the server, along with its applications and data, after a catastrophic failure or disaster.



## Configuration with a Stand-alone ARCserve Server

This setup involves a configuration where the CA ARCserve Backup server is installed on a separate standalone machine from the Replica server. The benefits of this configuration are as follows:

- Backups do not affect the functionality of the Replica server.
- Replication is quicker because the CA ARCserve Backup processes are running on a separate machine.
- This configuration meets the requirements for performing centralized backups for multiple remote branch offices (RBO).

The following diagram shows the requirements of this configuration:

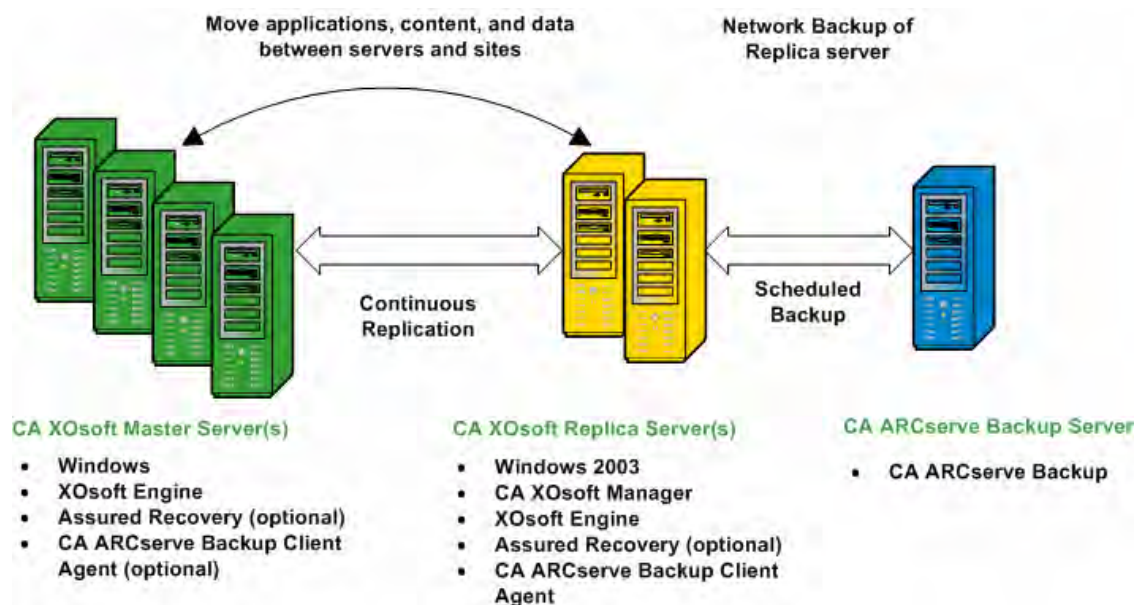

## Configuration with a CA ARCserve Backup Server Installed on a Replica Server

This setup involves a configuration where the CA ARCserve Backup server is installed on the same machine as the Replica server. This configuration lets you perform backups and restore jobs more quickly because these actions are performed local to the Replica server.

The following diagram shows the requirements of this configuration:

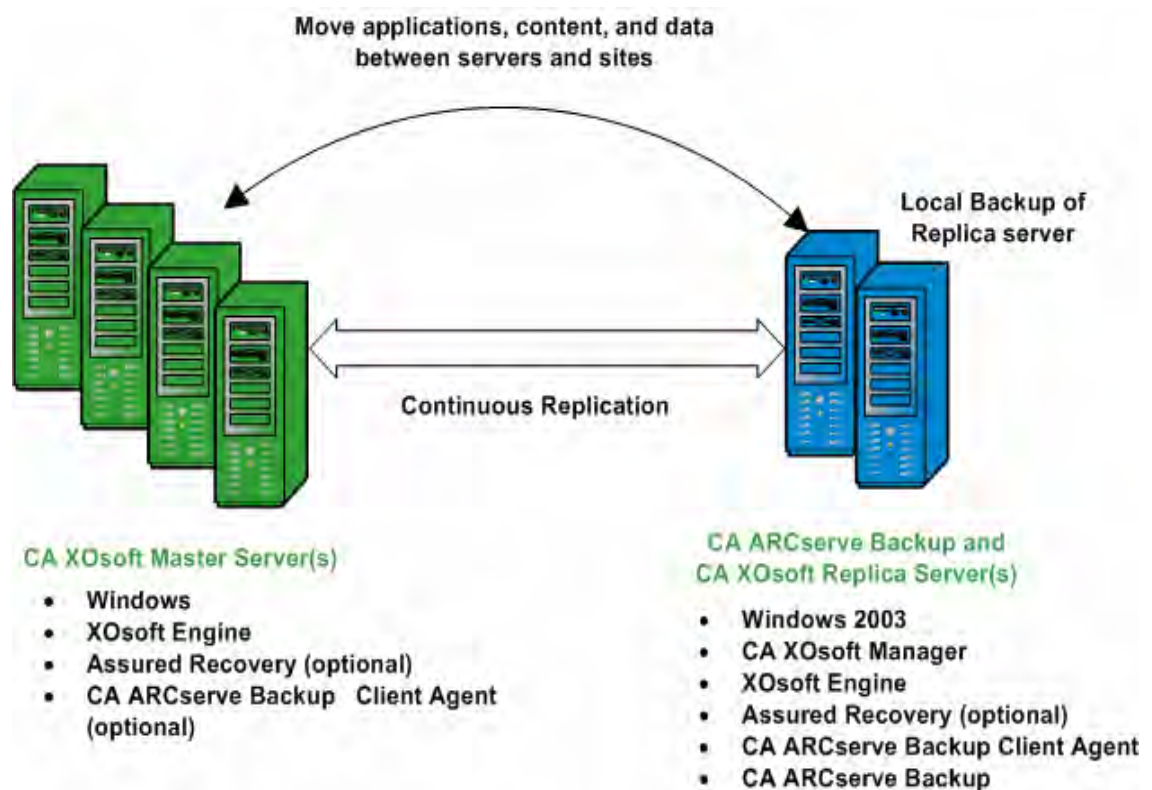

## Remote Branch Office (RBO) Configurations

CA ARCserve Backup and CA XOsoft together lets you replicate and back up data from remote branch office (RBO) servers to a central data center (CDC). These RBO servers can be externally connected via through WAN or a LAN.

The advantages of RBOs using a CDC are as follows:

- Better disaster recovery and continuous application availability for your branch office servers
- Centralized and consolidated backups of multiple branch offices at a single facility
- Reduced need for competent and sophisticated IT support at every location
- Reduced cost associated with installing and maintaining multiple servers, storage devices, and applications in many different locations
- Reduced security risk associated with tape transport, and offsets tape media and handling costs.

Remote branch offices can be set up for replication and backup in a variety of configurations, depending upon your requirements and capabilities. The following diagrams provide a few examples of RBO configurations.

## RBO Configuration Example 1

This example shows an RBO configuration of multiple Master servers being replicated to multiple Replica servers, and then backed up from a stand-alone CA ARCserve Backup server.

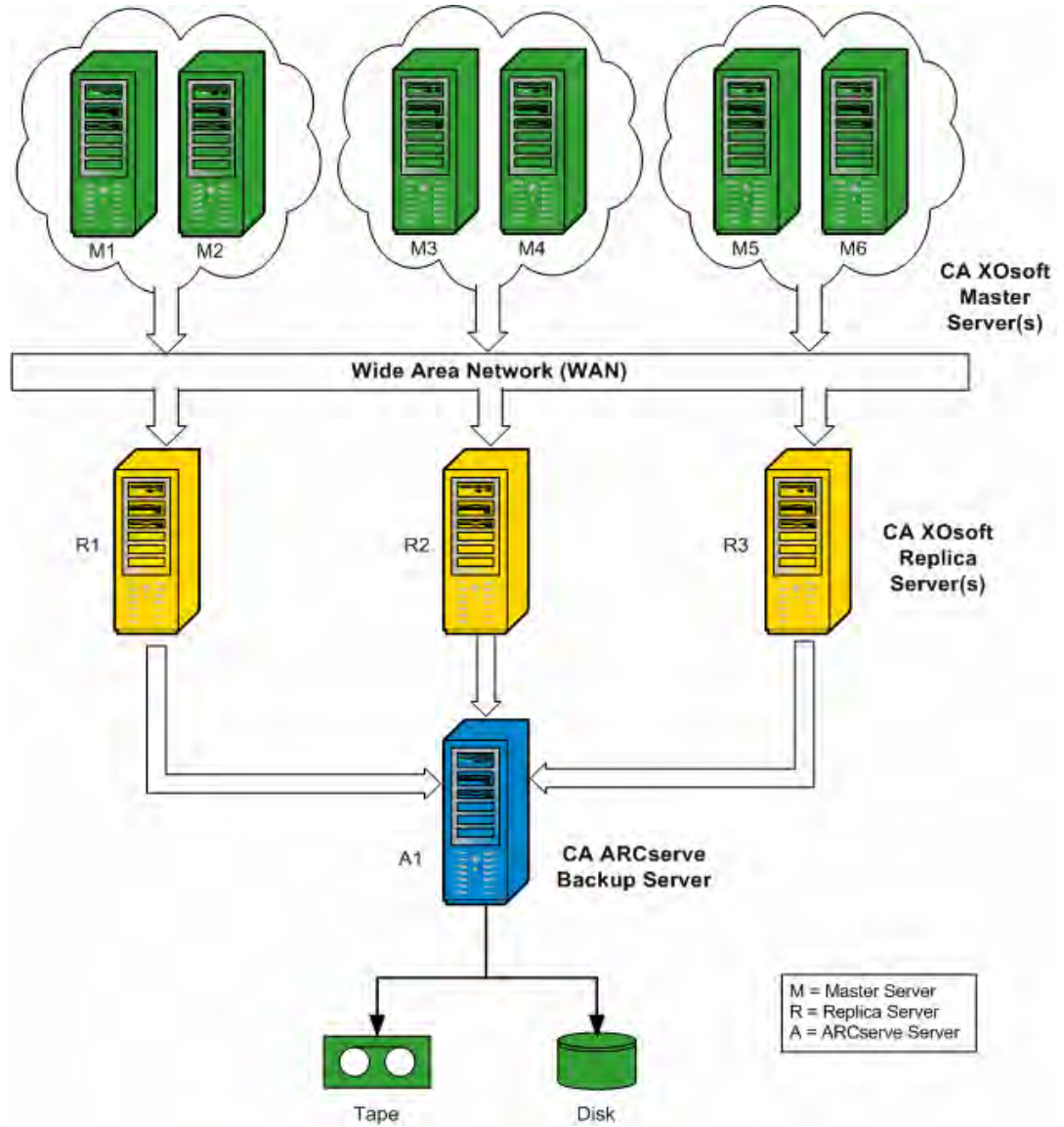

## RBO Configuration Example 2

This example shows an RBO configuration of multiple Master servers being replicated to multiple Replica servers, and then being backed up from a CA ARCserve Backup server installed on each Replica server to a common library. In addition to the other advantages associated with remote branch offices using a CDC, this configuration also provides the advantage of local backups of all CA ARCserve Backup servers.

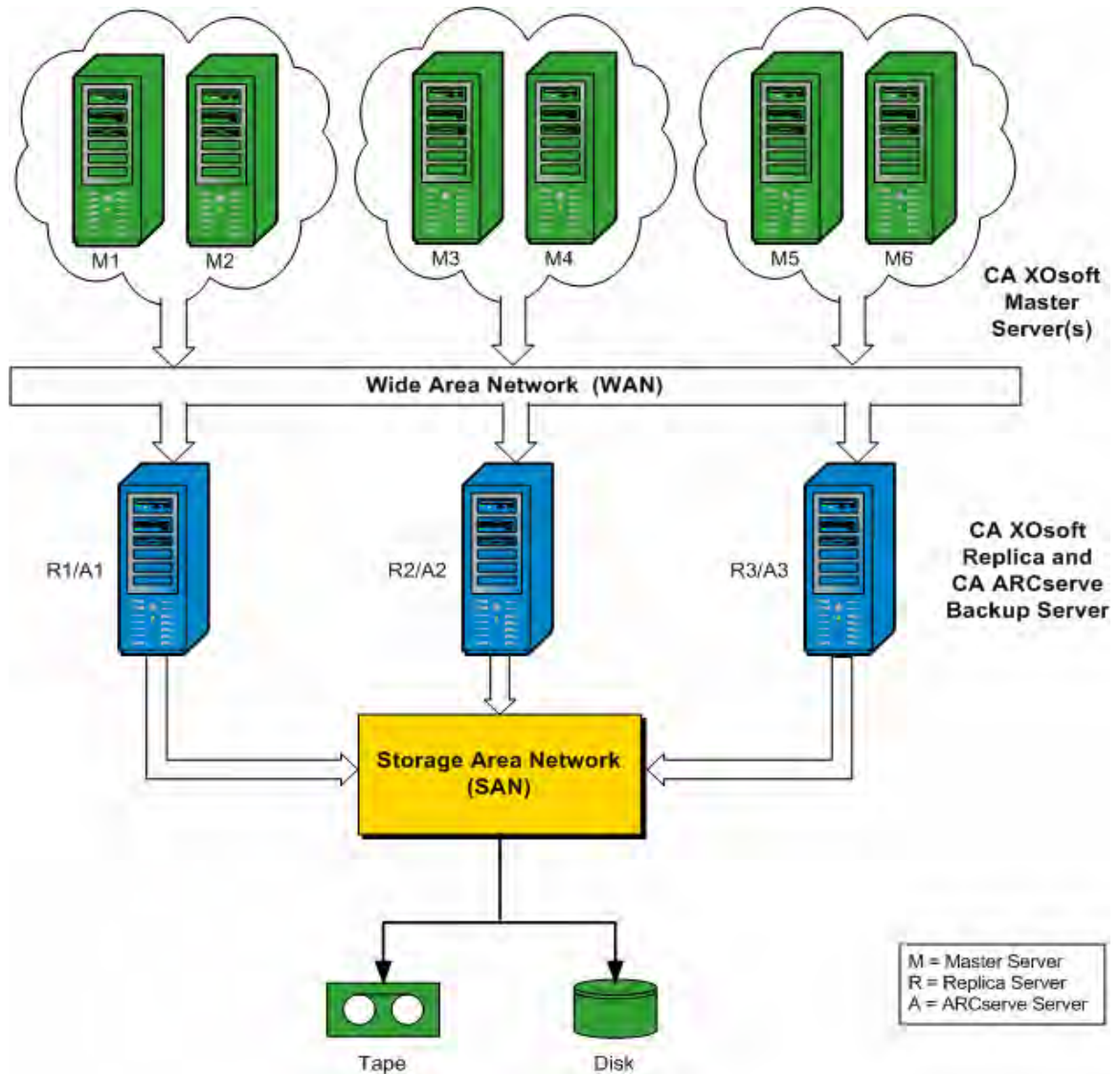

### RBO Configuration Example 3

This example shows an RBO configuration of multiple Master servers being replicated to a single Replica server, and then being backed up from a CA ARCserve Backup server installed on the Replica server. The disadvantage of this configuration is the bottleneck condition caused by the CA XOssoft Replica and CA ARCserve Backup server processing all replications and backups of multiple servers from multiple sites.

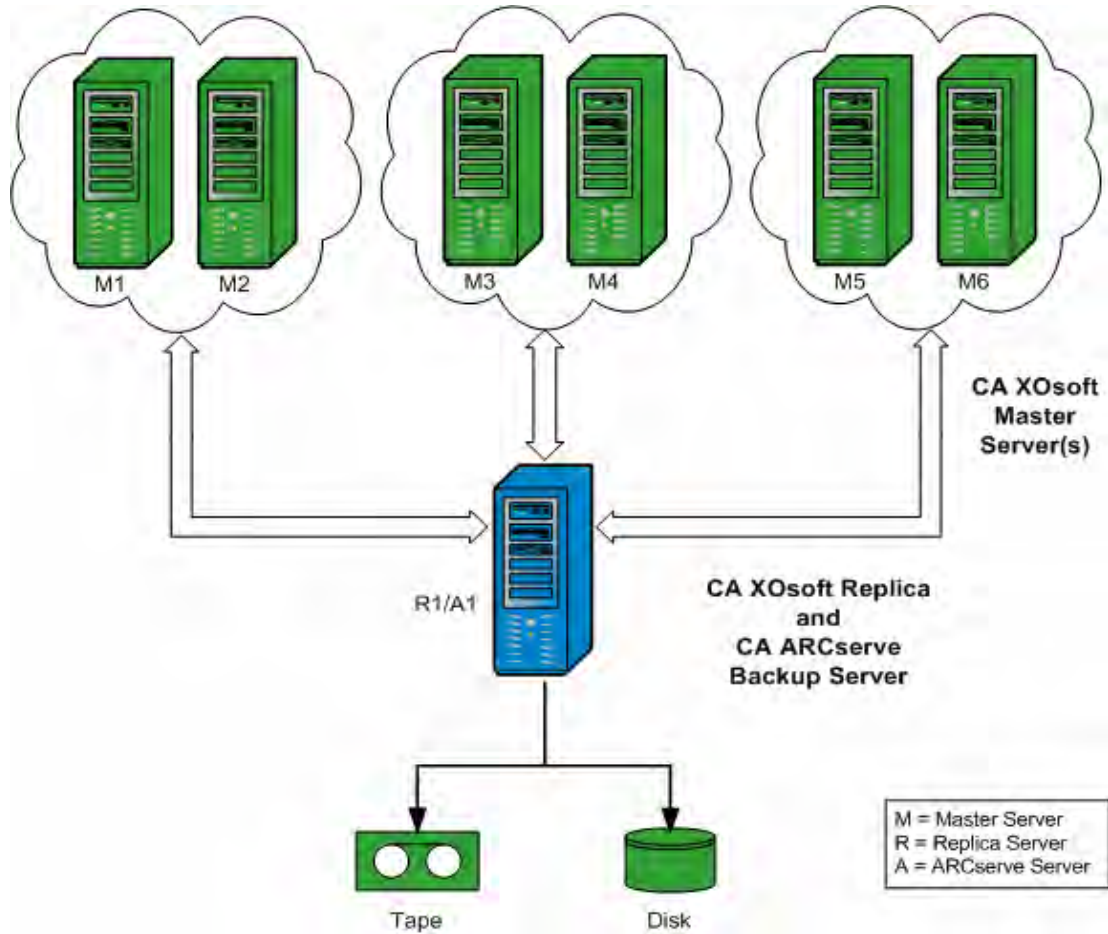



# Chapter 3: Performing Integrated Backup Jobs

---

This section contains the following topics:

- [Integrated Backup Jobs](#) (see page 31)
- [Create a CA XOsoft Scenario](#) (see page 31)
- [Run a CA XOsoft Scenario](#) (see page 36)
- [Create and Run a Backup Job](#) (see page 38)

## Integrated Backup Jobs

The integration between CA ARCserve Backup and CA XOsoft provides the dual benefit of continuous data protection and backup of this protected data. Through this integration, CA XOsoft provides real-time, continuous data replication from the Master server to the Replica server, while CA ARCserve Backup then backs up this replicated data from the Replica server to the CA ARCserve Backup server.

The process of performing an integrated backup involves the following operations:

- Creating a scenario
- Running a scenario
- Creating and Running a backup job

## Create a CA XOsoft Scenario

A CA XOsoft scenario is the basis for managing the operation of the system. A scenario is a structure that describes what applications and data are to be protected, where they are located, where the data is to be replicated, and other scenario-specific options. Before performing a backup of a CA XOsoft scenario, you must create a scenario to be backed up.

### To create a CA XOsoft scenario

1. Launch the CA XOsoft Manager from either the CA XOsoft start menu or from the CA ARCserve Backup Quick Start menu.

**Note:** For more information about replication scenarios and scenario creation options, see the *CA XOsoft User Guide*.

2. Click the New icon on the toolbar.

The Welcome to the New Scenario Wizard screen appears.

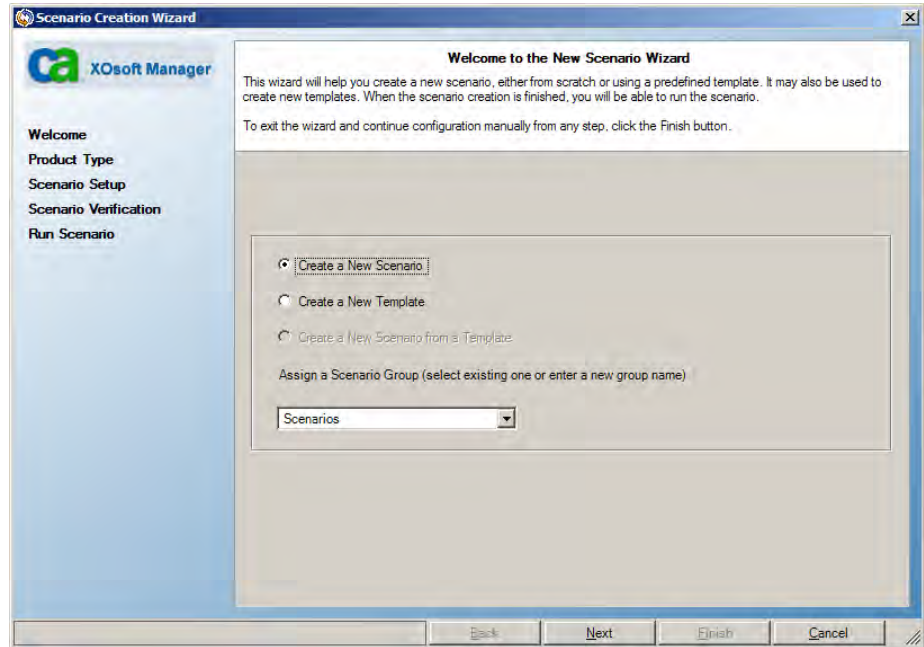

3. Select the Create New Scenario option and click Next to create a new scenario.

The Select Server and Product Type screen appears.

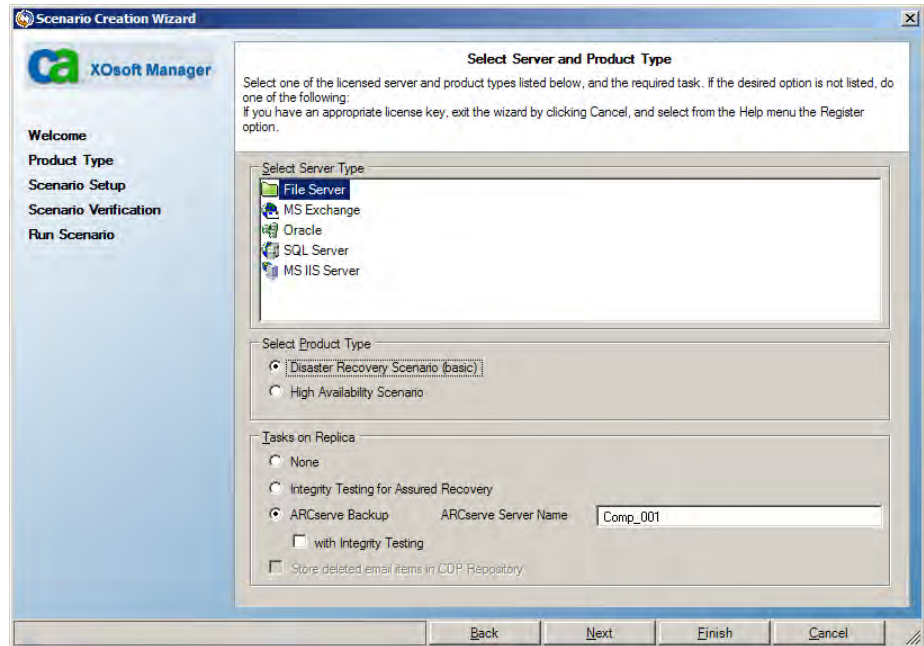



4. Select the ARCserve Backup option, select whether or not to include Integrity Testing, and enter the name of the CA ARCserve Backup server where the scenario will be backed up to. Select the appropriate Server Type, Product Type, and Assured Recovery (if available).

**Note:** CA ARCserve Backup supports File Server, MS Exchange, and SQL Server scenarios only.

5. Click Next.

The Master and Replica Hosts screen appears.

6. Enter the Scenario name for the scenario being created and the hostname or IP address for both the Master server and Replica server. You can also use the browse buttons next to each hostname field to select the corresponding locations.

The scenario to be backed up has been created and the related information has been inserted into the CA ARCserve Backup database.

**Note:** For an existing scenario, you can update the related information in the CA ARCserve Backup database by using the Update ARCServe Backup Server option, which is accessible from the Tools menu of the CA XOsoft Manager.

7. Click Next.

**Note:** If File Server or MS Exchange was selected as the scenario type, continue with the same scenario creation process as any other CA XOssoft scenario. For additional create scenario procedures, see the *CA XOssoft User Guide*.

If you selected SQL Server as the scenario type, the Master Configuration screen appears.

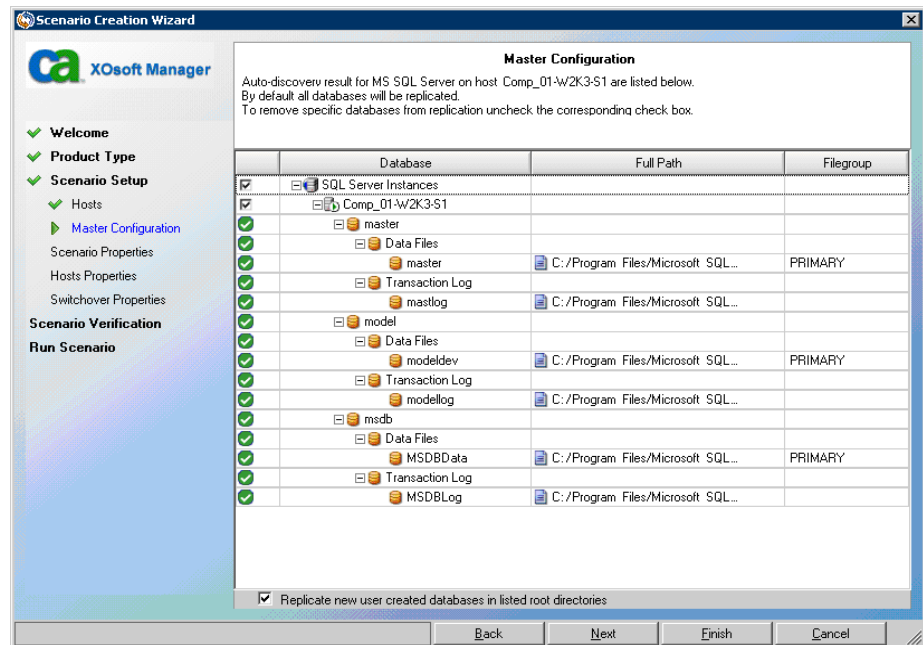

The Master Configuration screen displays all SQL Server databases for the master host, along with a check box for the "Replicate new user created databases in listed root directories" option.

With this option checked, if a new database is created in the SQL Server root directory after the scenario has been created, CA XOssoft will automatically begin to replicate the new database to the Replica server. However, because the newly created database has not been included in the CA ARCserve Backup database, the new database will not be backed up by CA ARCserve Backup. To allow the new database to be backed up, you must modify the scenario by running the CA XOssoft auto-discovery function so that the new database will be recognized and included in the CA ARCserve Backup database.

**Note:** The CA XOssoft auto-discovery function automatically discovers all database objects, related files, and directories on your database or mail server (local or on a network). For additional procedures about the auto discovery function, see the *CA XOssoft User Guide*.

8. After the SQL Server scenario is properly configured, click Next and continue with the same scenario creation process as any other CA XOssoft scenario.

**Note:** For additional create scenario procedures, see the *CA XOssoft User Guide*.

## Run a CA XOssoft Scenario

CA XOssoft creates and maintains backups in the context of user-defined scenarios. Before you back up a CA XOssoft scenario, you must run the scenario so that it is added to the CA ARCserve Backup database.

### To run a CA XOssoft scenario

1. From the CA XOssoft Manager interface, select the scenario to be backed up.
  - The scenarios and scenario status appear in the left pane.
  - The corresponding framework displaying directories (and subdirectories) and the files in those directories appear in the right pane.
  - The Events pane at the bottom displays information about significant events, warnings, and errors received from the host.

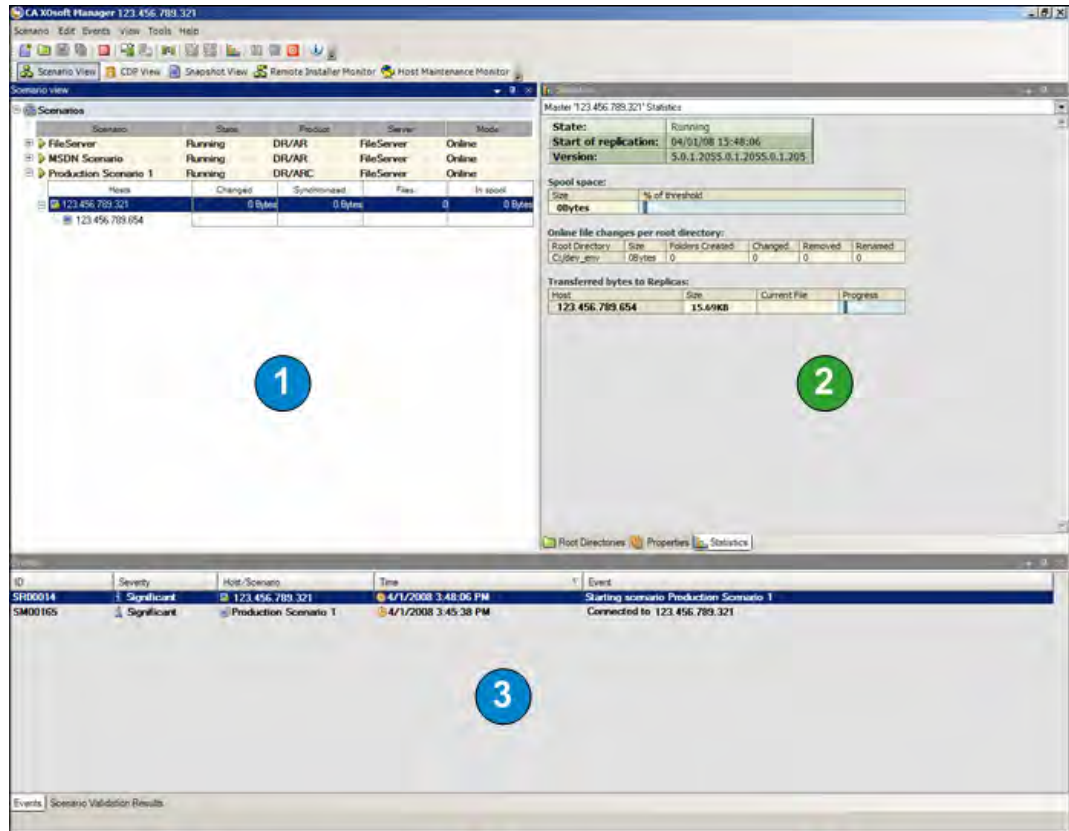

1 Scenario                      2 Framework                      3 Events

- Click the Run scenario icon on the toolbar.

The ARCserve Backup Server Connection dialog is displayed with the name of the server.

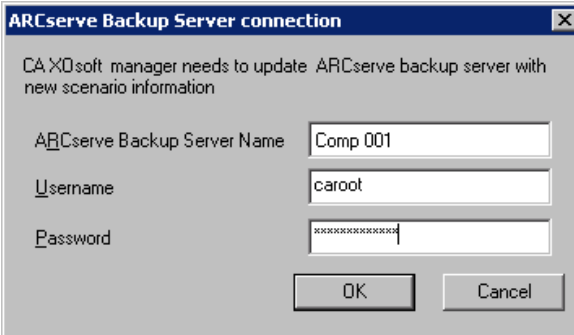

The dialog box is titled "ARCserve Backup Server connection". It contains the following fields and controls:

- ARCserve Backup Server Name: Comp 001
- Username: caroot
- Password: [masked with asterisks]
- Buttons: OK, Cancel

- On the ARCserve Backup Server Connection dialog, enter the proper username and password to allow the CA ARCserve Backup server to communicate with the agent on the Replica server.

The selected scenario is now added to the CA ARCserve Backup database and can be backed up.

**Note:** You can perform backups only when CA XOssoft is in the replication mode (green arrow icon next to scenario name).

The CA ARCserve Backup Activity Log will be updated to reflect any CA XOssoft operations related to creating, deleting, or modifying scenario records in the CA ARCserve Backup database.

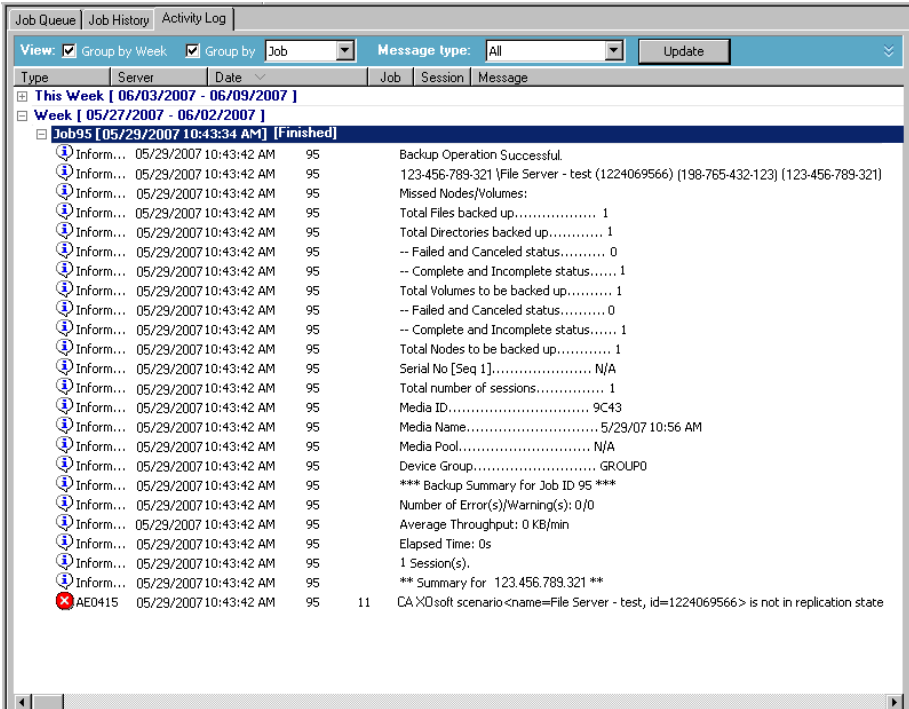

The screenshot shows the "Activity Log" window with the following details:

- View:  Group by Week,  Group by Job, Message type: All, Update
- Table columns: Type, Server, Date, Job, Session, Message
- Summary rows:
  - This Week [ 06/03/2007 - 06/09/2007 ]
  - Week [ 05/27/2007 - 06/02/2007 ]
  - Job95 [ 05/29/2007 10:43:34 AM ] [Finished]
- Log entries (Job 95):
  - Inform... 05/29/2007 10:43:42 AM 95 Backup Operation Successful.
  - Inform... 05/29/2007 10:43:42 AM 95 123-456-789-321 \File Server - test (1224069566) (198-765-432-123) (123-456-789-321)
  - Inform... 05/29/2007 10:43:42 AM 95 Missed Nodes/Volumes:
  - Inform... 05/29/2007 10:43:42 AM 95 Total Files backed up..... 1
  - Inform... 05/29/2007 10:43:42 AM 95 Total Directories backed up..... 1
  - Inform... 05/29/2007 10:43:42 AM 95 -- Failed and Canceled status..... 0
  - Inform... 05/29/2007 10:43:42 AM 95 -- Complete and Incomplete status..... 1
  - Inform... 05/29/2007 10:43:42 AM 95 Total Volumes to be backed up..... 1
  - Inform... 05/29/2007 10:43:42 AM 95 -- Failed and Canceled status..... 0
  - Inform... 05/29/2007 10:43:42 AM 95 -- Complete and Incomplete status..... 1
  - Inform... 05/29/2007 10:43:42 AM 95 Total Nodes to be backed up..... 1
  - Inform... 05/29/2007 10:43:42 AM 95 Serial No [Seq 1]..... N/A
  - Inform... 05/29/2007 10:43:42 AM 95 Total number of sessions..... 1
  - Inform... 05/29/2007 10:43:42 AM 95 Media ID..... 9C43
  - Inform... 05/29/2007 10:43:42 AM 95 Media Name..... 5/29/07 10:56 AM
  - Inform... 05/29/2007 10:43:42 AM 95 Media Pool..... N/A
  - Inform... 05/29/2007 10:43:42 AM 95 Device Group..... GROUP0
  - Inform... 05/29/2007 10:43:42 AM 95 \*\*\* Backup Summary for Job ID 95 \*\*\*
  - Inform... 05/29/2007 10:43:42 AM 95 Number of Error(s)/Warning(s): 0/0
  - Inform... 05/29/2007 10:43:42 AM 95 Average Throughput: 0 KB/min
  - Inform... 05/29/2007 10:43:42 AM 95 Elapsed Time: 0s
  - Inform... 05/29/2007 10:43:42 AM 95 1 Session(s).
  - Inform... 05/29/2007 10:43:42 AM 95 \*\* Summary for 123.456.789.321 \*\*
  - AE0415 05/29/2007 10:43:42 AM 95 11 CA XOssoft scenario <name=File Server - test, id=1224069566> is not in replication state

## Create and Run a Backup Job

After a CA XOssoft scenario has been added to the CA ARCserve Backup database a backup job can be created.

### To create and run a backup job

1. From CA ARCserve Backup, access the Backup Manager and select the Source tab.

The left pane of the Source tab lists all of the CA XOssoft scenarios that have been registered in the CA ARCserve Backup database and are candidates for being backed up.

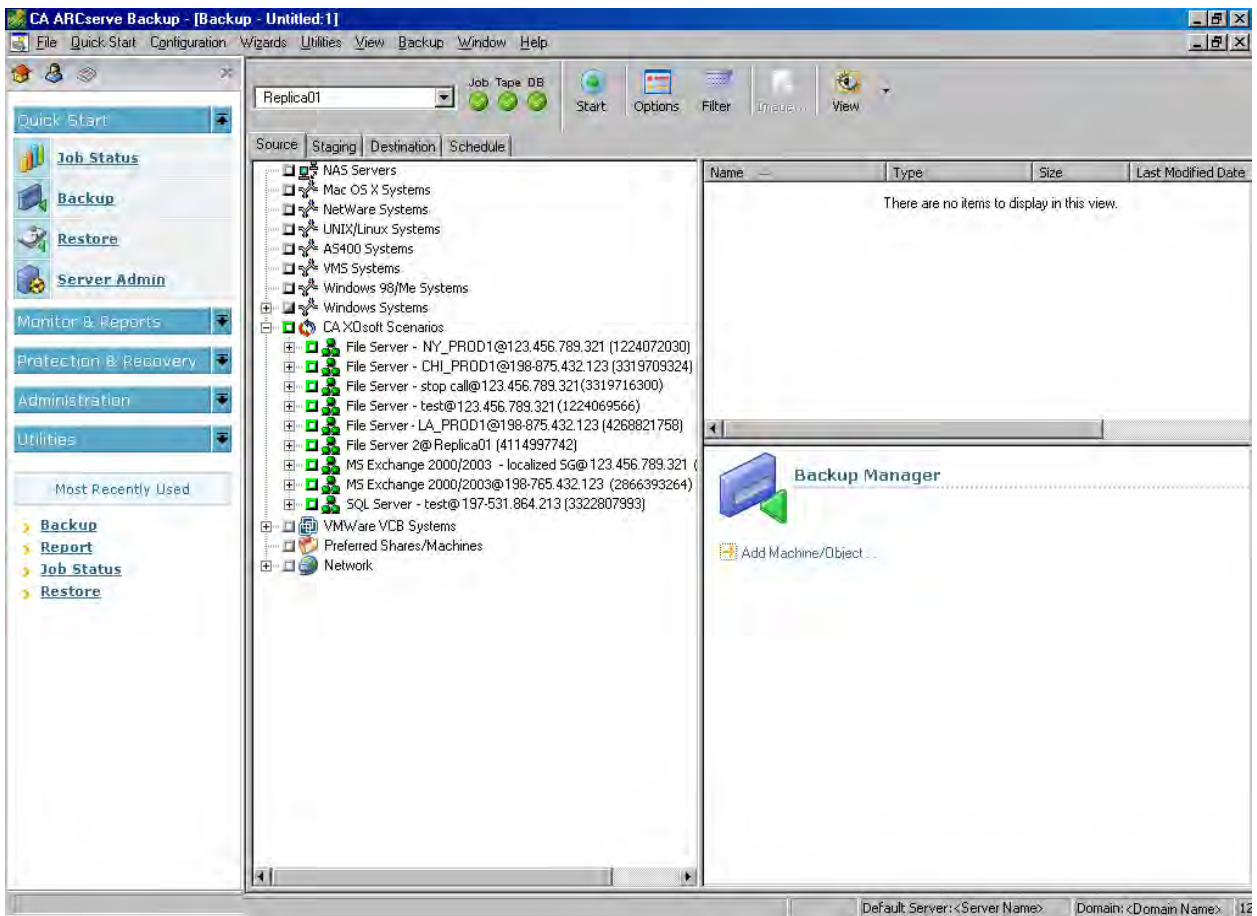

- Expand the CA XOssoft Scenarios directory and select the scenario to be backed up.

The Security dialog appears, prompting you to provide the user name and password to log in into the CA ARCserve Backup Client Agent running on the **Replica** server.

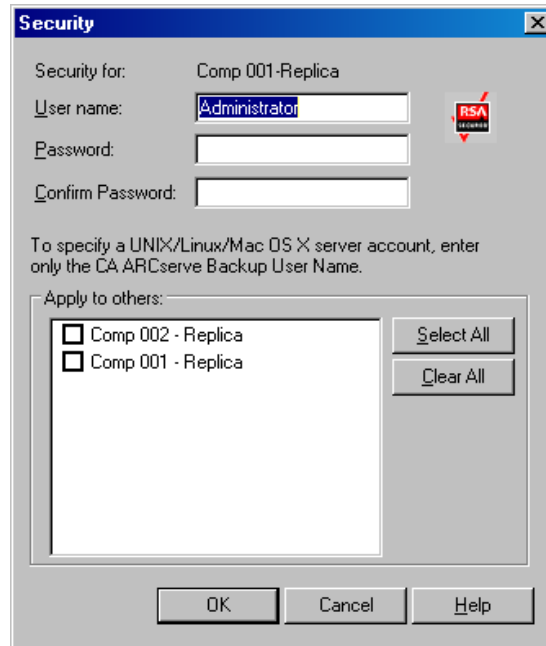

- Enter the user name and password and click OK.

**Note:** CA ARCserve Backup does not support logging in to systems with passwords that are greater than 23 characters. If the password on the system you are attempting to log in to is greater than 23 characters, you must modify the password on the agent system such that it is 23 characters or less, and then you can log in to the agent system.

If the credentials are accepted, you can select a scenario for backup.

4. Expand the scenario to view the entities contained within the scenario to be backed up.

The scenario is expanded to display the associated entities. You can only view individual entities and not select them for backup. Supported scenarios include File Server, MS Exchange, and SQL Server.

**Note:** Depending upon the type of scenario stored in the CA ARCserve Backup server (File Server, MS Exchange, or SQL Server), different entities within each scenario are displayed.

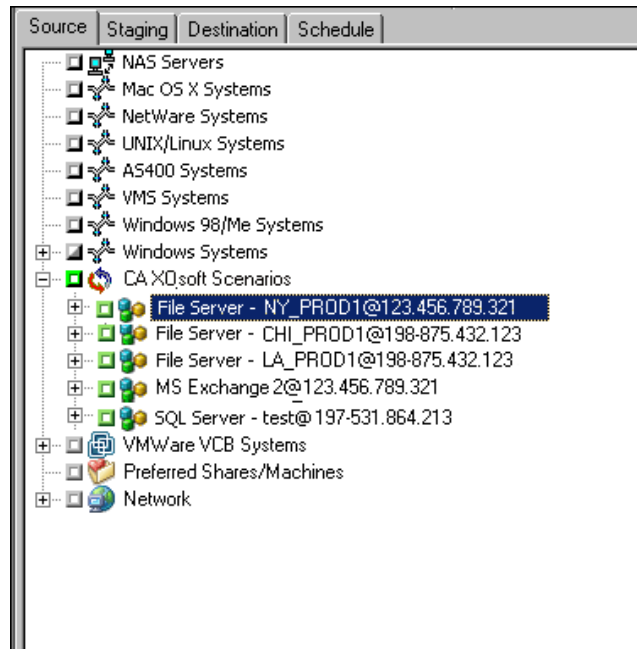



5. Select the scenario you want to back up.

The marker box next to the selected scenario is filled solid and the corresponding scenario properties are displayed in the right pane of the Backup Manager. All backups are full backups (not incremental or differential).

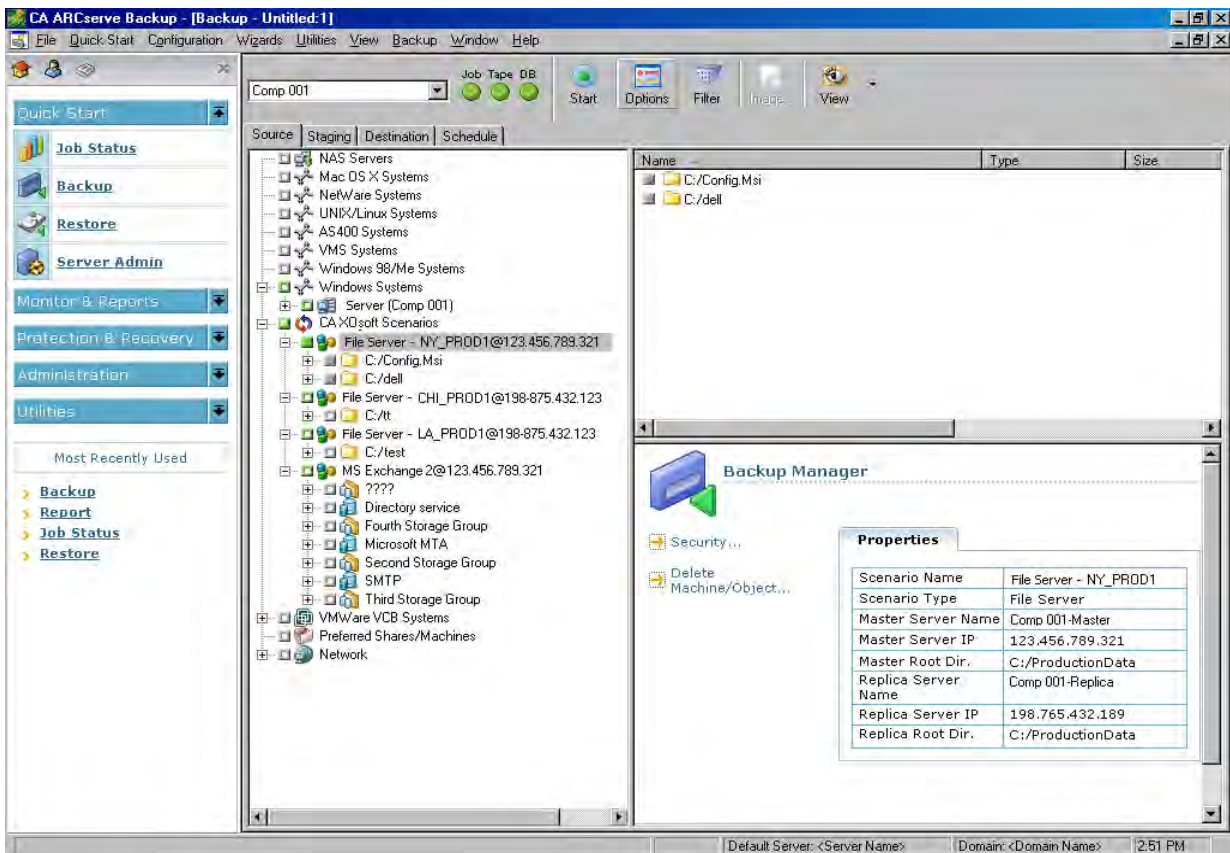

The backup job creates a session for each entity that constitutes a scenario. The level of granularity for an entity depends on the type of scenario (File Server, MS Exchange, or SQL Server).

For multistreaming backup jobs, each CA XOsoft scenario is backed up as a child job. If one node contains multiple scenarios, the master job will split them so that each child job will back up one scenario.

**Note:** You can back up entire scenarios only.



6. Make the relevant selections for Staging, Destination, Schedule, Global Options, and any other backup-related options. You can select multiple CA XOsoft scenarios or include non-CA XOsoft scenarios in the backup.

**Note:** For more information about these backup options, see the *CA ARCserve Backup Administration Guide*.

7. From the Backup Manager, click Start to initiate the backup.

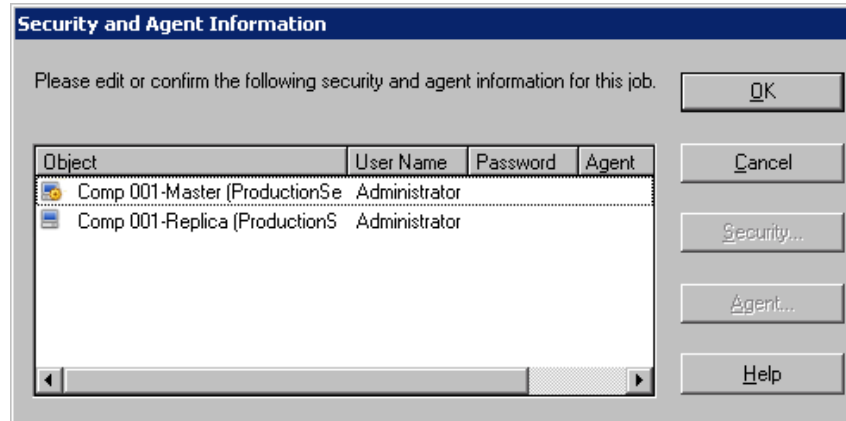
The Security and Agent Information dialog appears and displays information about the selected scenario.



Each CA XOsoft scenario displays two sets of credentials; one for the Master server and one for the associated Replica server. A graphic symbol next to the server name indicates if the server is a Master (active) server  or a Replica (standby) server .

The Master server credentials are used to log in to the CA XOsoft engine, while the Replica server credentials are used to log in to the CA ARCserve Backup Client Agent running on the Replica server.

**Note:** The Master server credentials cannot be verified by the Preflight Checklist (PFC) utility.

8. Select the applicable server and click Security.

The Security dialog will appear for the selected server.

9. Enter the user name and password, and click OK.

**Note:** CA ARCserve Backup does not support logging in to systems with passwords that are greater than 23 characters. If the password on the system you are attempting to log in to is greater than 23 characters, you must modify the password on the agent system such that it is 23 characters or less, and then you can log in to the agent system.

The Submit Job dialog appears.

Continue the backup procedure as usual. For more information about this procedure, see the *CA ARCserve Backup Administration Guide*.

10. When the backup procedure is completed, click OK to submit the backup job

Depending upon selected options, the backup job is either run immediately or entered in the job queue to be executed at the scheduled time.

**Important!** If you access the CA XOssoft Manager while the backup job is running, a pop-up message indicates that the specified scenario is locked from another host and asks you to press OK to take control. If you press OK, the backup job will fail because CA ARCserve Backup is no longer controlling the scenario. To successfully complete the backup job, you must not open the CA XOssoft Manager, click Cancel, or ignore the message and not press OK.



# Chapter 4: Performing Integrated Restore Jobs

---

This section contains the following topics:

[Integrated Restore Jobs](#) (see page 45)

[Restore Using CA XOsoft Failover](#) (see page 46)

[Restore Using CA XOsoft Data Rewind](#) (see page 46)

[Restore Using CA ARCserve Backup](#) (see page 47)

## Integrated Restore Jobs

The integration between CA ARCserve Backup and CA XOsoft lets you restore backed-up data from a variety of sources with a variety of methods.

The process of performing an integrated restore involves the following operations:

- Restore using CA XOsoft Failover
- Restore using CA XOsoft Data Rewind
- Restore using CA ARCserve Backup

## Restore Using CA XOsoft Failover

Failover is a restore method that detects when the protected application on the Master server fails and switches (either automatically or manually activated) to a designated Replica server with essentially zero loss of data and time. If a Master server fails or must be shut down for maintenance, a synchronized replica (locally or in a remote location) will instantly and automatically take its place.

The advantage of a CA XOsoft restore using the failover feature is that data processing resumes immediately if there is a hardware failure on the Master server. You can recover data almost immediately from the Replica server, without any disruptions or loss of data or service.

Automatic failover is designed to allow applications that are running on the Master server to automatically switch to the Replica server. This process can either be completely transparent or it can be configured to require user intervention.

Manual failover can be initiated for a number of reasons (usually for maintenance purposes), but it still results in the switching of the application processes from the Master server to the Replica server.

**Note:** For detailed procedures about recovering lost data from a Replica server using the failover feature, see the *CA XOsoft User Guide*.

## Restore Using CA XOsoft Data Rewind

Data Rewind is a restore method lets you rewind files to a point in time (rewind point) before they were corrupted. Because replication continuously updates source data to the Replica server, the Replica server always holds the same data as in the Master server. In the case of data corruption, recovering the latest files from the Replica server will not help, because that data in the Replica server is also corrupted. These rewind points serve as checkpoints in the Rewind log that mark an event or operation. The actual information stored includes the operation that will undo the event if the rewind point is activated. Data recovery uses these rewind points or bookmarks in the Rewind log to reset the current data back to a previous state. Because this built-in rewind technology occurs on the Replica server, any "data rewinding" to a previous state can only be performed on the Replica server.

The advantages of a CA XOsoft restore using the data rewind feature are very quick recovery, extreme granularity of the recoverable data, and application-aware replication and recovery.

**Note:** For detailed procedures about recovering lost data from a Replica server using the Data Rewind feature, see the *CA XOsoft User Guide*.

## Restore Using CA ARCserve Backup

You can recover data that was replicated from the CA XOssoft Master server to the CA XOssoft Replica server and then backed up with CA ARCserve Backup using the following methods:

- Restore by Session
- Restore by Tree
- Restore by Query

When restoring to a Replica server, ensure that the corresponding application is not running to avoid attempting to restore files that are currently in use. When restoring to the Master server, ensure that the CA ARCserve Backup Client Agent is installed and running.

**Note:** For SQL Server and MS Exchange scenarios, only full session restores are supported. For File Server scenarios, more granular restores to the specific files, directories, or volumes are supported.

In addition, regardless of the restore method being used, you can also make the relevant selections for Schedule, Global Options, and any other restore-related options. For more information about these restore options, see the *CA ARCserve Backup Administration Guide*.

## Set CA XOssoft-specific Global Restore Option

The Restore Manager contains a CA XOssoft-specific global restore option that can be set regardless of which restore method is selected.

### To set the CA XOssoft-specific global restore option

1. From the Restore Manager window, click the Options toolbar button.

The Global Options dialog appears.

2. Select the Operation tab.

The Operation dialog appears, displaying the CA XOssoft-specific "Continue the restore job even when the scenario cannot be stopped" option.

By default, this option is not checked, indicating that if CA XOssoft cannot stop the scenario during the restore process, the job will fail. If you check this option, CA XOssoft will still try to stop the scenario; however, if the scenario cannot be stopped, the restore job will continue. This option has the following advantage and disadvantage:

- The advantage of checking this option is that you are more likely to have a successful restore.
- The disadvantage of checking this option is that with the scenario running and continuous replication being performed, any problems that are contained on the Master server will overwrite the restored data on the Replica server.

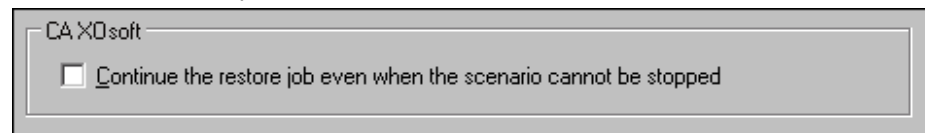

## Restore by Session

The Restore by Session method lets you select the session and the files and directories you want to restore. Use this method when you know the media name, but are not certain about the session you want to restore. This view uses the CA ARCserve Backup database; if the database engine is stopped, this method of restore will not work.

### To restore a backup job by session

1. From CA ARCserve Backup, access the Restore Manager, select the Source tab, and choose Restore by Session from the Source View drop-down list.

The left pane of the Restore Manager lists all of the CA XOssoft Scenarios that have been backed up and are candidates for being restored.



2. Select the session to be restored.

The corresponding session content and properties are displayed in the right panes of the Restore Manager.

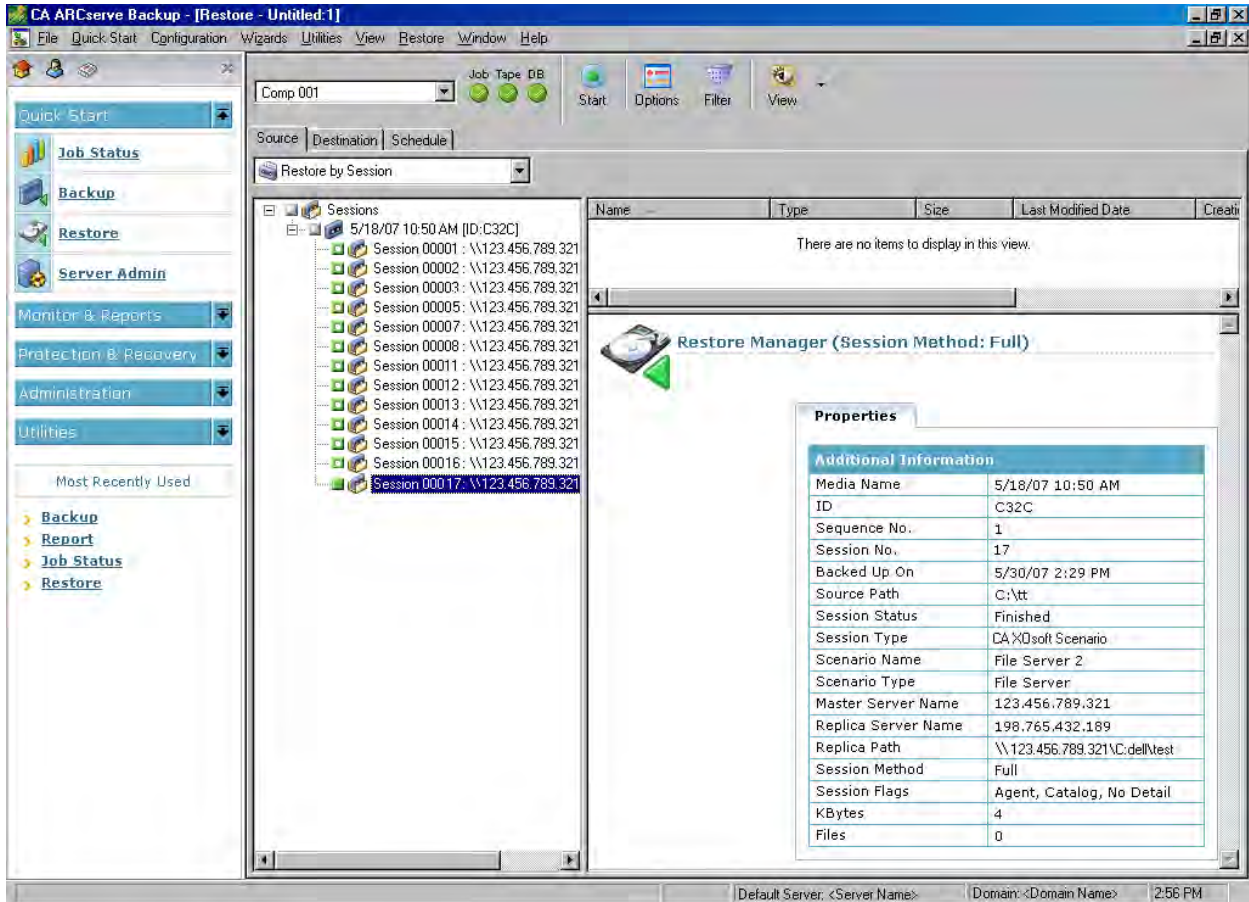

3. Select the Destination tab and specify the destination where you want the restored files to go.

You can restore source files to the same directory structure that they originated from (original location) or to any other location that you specify (alternate location).

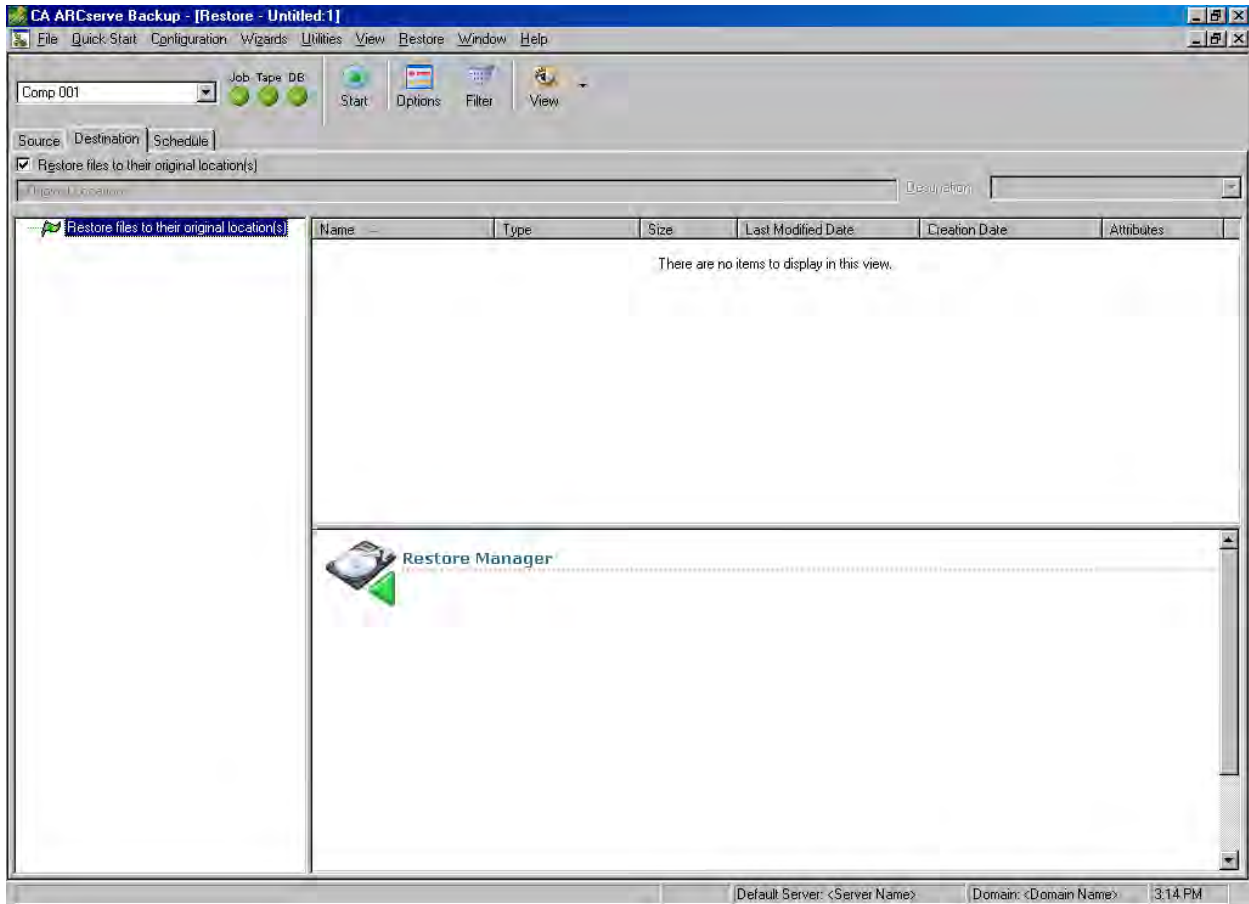

4. To restore the files to their original location (default option), perform the following tasks:
  - a. Ensure the Restore files to their original location(s) option check box is checked and click the Start button to run the job.

The Session User Name and Password dialog appears.

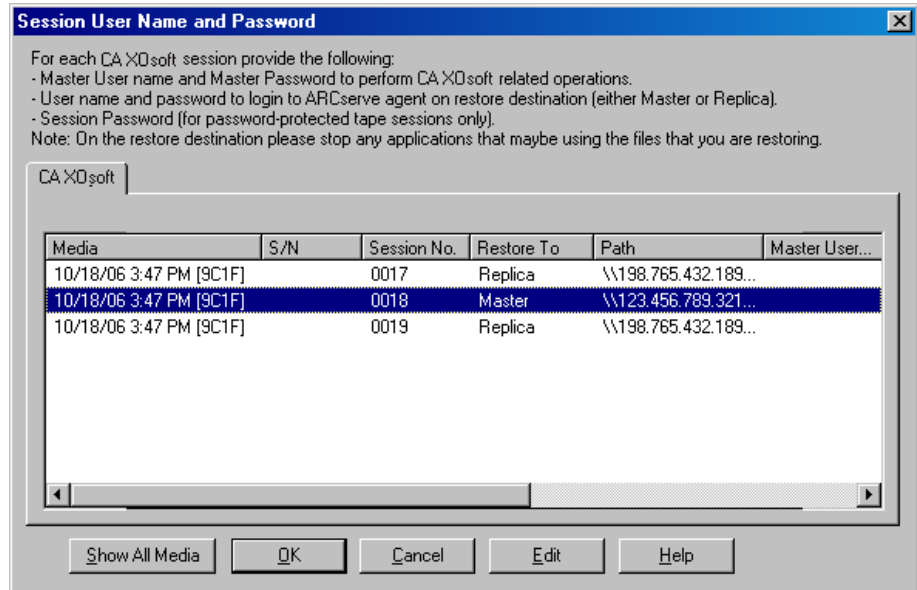

For SQL Server and MS Exchange, if the corresponding application is running and you restore a CA XOSoft scenario to the original location, the restored files are temporarily created with a .TMP extension. After the restore job is successful, you are prompted to reboot the server to overwrite and replace the existing active files. When the server is rebooted, the restored files are merged into the original database. If the corresponding application is not running, temporary files will not be created during the restore to original location process and you do not have to reboot the server.

**Important!** Rebooting a SQL Server installed on a Cluster environment is not feasible, so you must stop the application resource before performing a restore to the original location.

- b. Select the server (Master or Replica) to restore the files to, and either double-click the selected row or click Edit.

The Enter User Name and Password for CA XOsoft Session dialog appears.

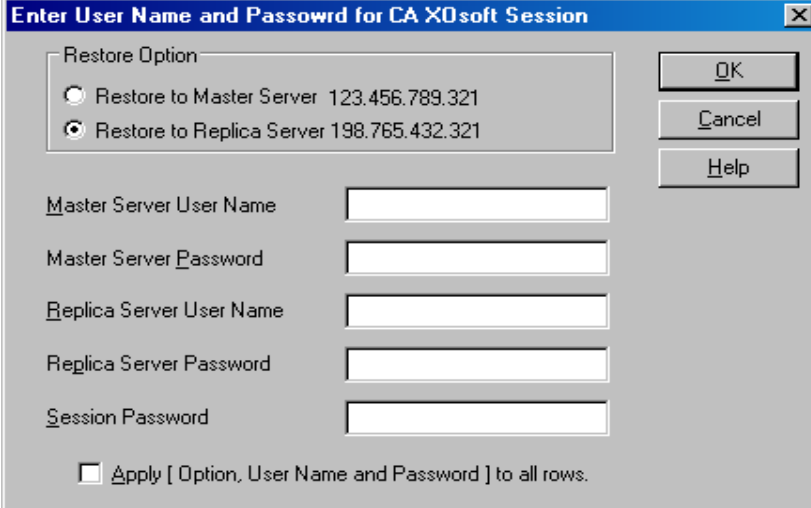

- c. Select the Restore Option as either Restore to Master Server or Restore to Replica Server.

By default, the Replica server is selected because restoring to a Replica server is usually more efficient and does not interrupt operation of the production (Master) server. Select Restore to a Master server only if you need a faster recovery or if you need to reconstruct the Master server environment (if corrupted).

**Note:** When restoring to a Replica server, ensure that the corresponding application is not running to avoid attempting to restore files that are currently in use. When restoring to the Master server, ensure that the CA ARCserve Backup Client Agent is installed and running.

- d. Enter the server security credentials (User Name and Password) and Session Password.
- If you chose to restore to a Replica server, you must provide the security credentials to access both the Master server and the Replica server.
  - If you chose to restore to a Master server, you must provide only the security credentials to access the Master server.

- e. Click OK.

The Submit Job dialog appears.

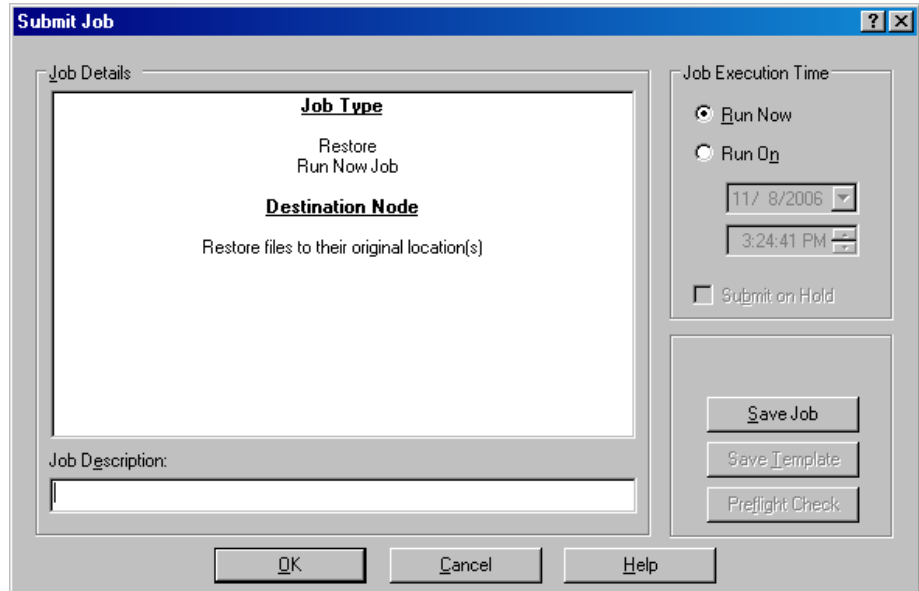

- f. Continue with the same restore procedure as detailed for any other CA ARCserve Backup restore job. For more information about this procedure, see the *CA ARCserve Backup Administration Guide*.

5. To restore the files to an alternate location, perform the following tasks:
  - a. Remove the check from the Restore files to their original location(s) option check box and select a destination folder.

The destination where you want the restored files to go is now specified.

**Important!** A CA XOsoft restore is supported only through a Windows Systems Client Agent. As a result, the alternate restore location must be a destination machine or volume that is under the Windows Systems Client Agent tree. If you try to restore to the Server tree or any other tree not under the Client Agent tree, the restore job will fail. If necessary you can add a new Client Agent machine. For procedures on adding a new client object, see the CA ARCserve Backup online help system.

- b. Click Start to run the job.

The Session User Name and Password dialog appears.

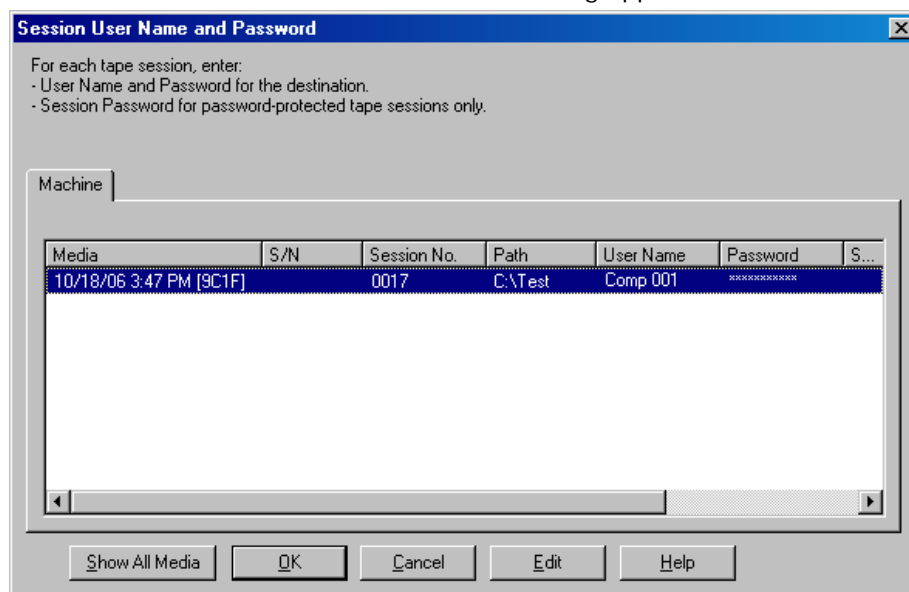

- c. Select the machine to restore the files to, and either double-click the selected row or click the Edit.

The Enter User Name and Password dialog appears.

- d. Enter the security credentials (User Name and Password), and click OK.

The Submit Job dialog appears.

- e. Continue with the same restore procedure as detailed for any other CA ARCserve Backup restore job. For more information about this procedure, see the *CA ARCserve Backup Administration Guide*.

## Restore by Tree

The Restore by Tree method restores a specific directory or drive from a display of files and directories that were backed up with CA ARCserve Backup. Use this method when you do not know which media contains the data you need, but you know the machine from which the backup originated.

The Restore by Tree view displays only the last instance of a backup. To view and access all other instances, select the object that you want to restore and click the Version History button. The Restore by Tree view displays only the Master server specific view.

### To restore a backup job by tree

1. From CA ARCserve Backup, access the Restore Manager, select the Source tab, and choose Restore by Tree from the Source View drop-down list.

**Note:** If necessary, you can click Version History to view and select a different version of the object you want to restore.

The left pane of the Restore Manager lists the volumes, drives, directories, and files that have been backed up and are candidates for being restored.

2. Select the data to be restored.

The corresponding content and properties are displayed in the right panes of the Restore Manager.

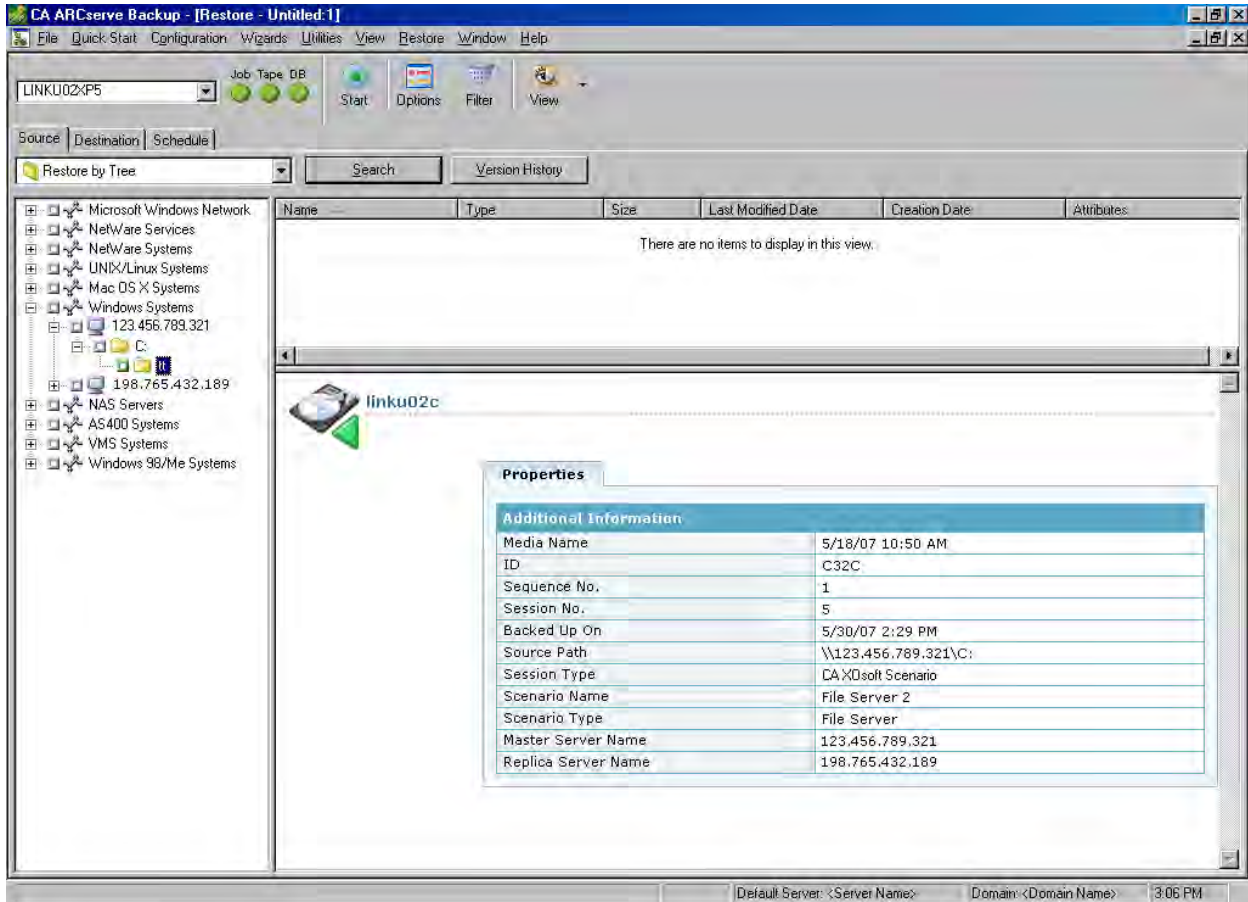



3. Select the Destination tab and specify the destination where you want the restored files to go. Source files can be restored to the same directory structure that they originated from (original location) or to any other location that you specify (alternate location).

The destination where you want the restored files to go is now specified.

The Session User Name and Password dialog appears.

For SQL Server and MS Exchange, if the corresponding application is running and you restore a CA XOsoft scenario to the original location, the restored files are temporarily created with a .TMP extension. After the restore job is successful, you are prompted to reboot the server to overwrite and replace the existing active files. When the server is rebooted, the restored files are merged into the original database. If the corresponding application is not running, temporary files will not be created during the restore to original location process and you do not have to reboot the server.

A CA XOsoft restore is only supported through a Windows Systems Client Agent. As a result, the alternate restore location must be a destination machine or volume that is under the Windows Systems Client Agent tree. If you try to restore to the Server tree or any other tree not under the Client Agent tree, the restore job will fail. If necessary you can add a new Client Agent machine. For procedures on adding a new client object, see the CA ARCserve Backup online help system.

**Important!** Rebooting a SQL Server installed on a cluster environment is not feasible, so you must stop the application resource before performing a restore to the original location.

4. Continue with the same restore procedure the as detailed for the Restore by Session method.

## Restore by Query

The Restore by Query method restores files based on the search pattern used to locate the names of the files or directories. Use this method when you know the name of the file or directory you want to restore, but do not know the machine it was backed up from or the media it was backed up to. This view uses the CA ARCserve Backup database.

**Note:** The Restore by Query method only supports File Server scenarios.

### To restore a backup job by query

1. From CA ARCserve Backup, access the Restore Manager, select the Source tab, and choose Restore by Query from the Source View drop-down menu.

The top pane of the Restore Manager displays fields let you enter the search criteria for the scenarios that have been backed up and are candidates for being restored.

2. Specify the search criteria and click Query.

The bottom pane of the Restore Manager displays all the returned items that match the query criteria.

3. Select the files or directories that you want to restore and click Start to run the job.

If the selected file or directory is a CA XOsoft scenario, the Enter User Name and Password for CA XOsoft Session dialog appears.

**Enter User Name and Password for CA XOsoft Session**

Restore Option

Restore to Master Server 123.456.789.321

Restore to Replica Server 198.765.432.321

OK

Cancel

Help

Master Server User Name

Master Server Password

Replica Server User Name

Replica Server Password

Session Password

Apply [ Option, User Name and Password ] to all rows.

If the selected file or directory is not a CA XOsoft scenario, the Session User Name and Password dialog appears.

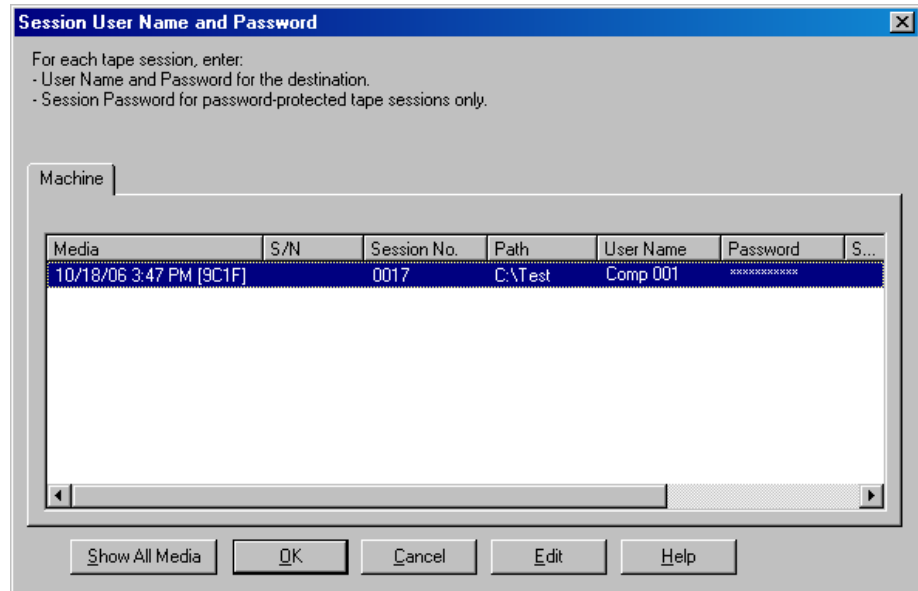

4. Continue with the same restore procedure the as detailed for the Restore by Session method.

## Restore MS Exchange Scenario to Master Machine

When restoring backup data from a MS Exchange scenario to the Master server, the mailbox store is not automatically dismounted before the restore and mounted after the restore job is finished. You will need to perform the following procedure to restore an Exchange Storage Group to the Master server.

### Restore a MS Exchange scenario to the Master server

1. From the Exchange Management Console, individually dismount each database in the storage group that you are restoring.

All databases in the storage group are dismounted.

2. Access the Microsoft Exchange Server Mailbox folder(s) and delete all storage group files from the folder.

All storage group files are deleted.

**Note:** If enough free disk space is available on your server, you can rename the folder instead of deleting the contents and then delete it after the restore job is successful.

3. Perform the restore to the Master server (using the Restore by Session, Restore by Tree, or Restore by Query method).
4. When the restore is successfully completed, return to the Exchange Management Console and mount each database in the storage group that was just restored.

# Chapter 5: Monitoring Backup and Replication Jobs

---

This section contains the following topics:

[Integrated Job Monitoring](#) (see page 61)

[Monitor Job Status Using CA ARCserve Backup](#) (see page 61)

[Monitor Job Status Using CA XOssoft](#) (see page 63)

[Alert Notification](#) (see page 66)

[Report Generation](#) (see page 68)

## Integrated Job Monitoring

Monitoring the status of backup and replication jobs consists of a combination of real-time event monitoring, generated alerts, and various reports. You can monitor an entire integrated backup process using CA ARCserve Backup and CA XOssoft.

## Monitor Job Status Using CA ARCserve Backup

The procedure for monitoring the backup process does not change for the integrated environment. For more information about monitoring the backup process, see the *CA ARCserve Backup Administration Guide*.

You monitor the integrated backup process from CA ARCserve Backup through the Job Status Manager. The Job Status Manager is a graphical tool that helps you to centrally manage CA ARCserve Backup servers across the enterprise and monitors all pending, completed, and active jobs from the Job Status Manager window. The Job Status Manager window contains a Job Queue tab and an Activity Log tab to monitor.

## Job Queue Monitoring

The Job Queue tab on the right panel displays information about all jobs. Every time you run or schedule a job with the CA ARCserve Backup Backup Manager, you submit it to the Job Queue. CA ARCserve Backup continuously scans the Job Queue for jobs that are waiting to execute.

When a job is in the CA ARCserve Backup queue, it is listed with a status. The status can be one of the following:

**Done** 

Indicates a job that has already been executed with no repeat interval.

**Ready** 

Indicates a new one-time or repeating job waiting to be executed. For example, a backup job that runs every Friday.

**Active** 

Indicates a job that is currently being executed.

**Hold** 

Indicates a job that is in the queue waiting to be executed later.

When an integrated backup job is submitted, the scenario name is displayed in the Job Queue window, letting you monitor the progress of the job.

## Activity Log Monitoring

The Activity Log tab on the right panel displays comprehensive information about all the operations performed by CA ARCserve Backup. The Activity Log provides an audit trail of every job that is run. For each job, the log includes the following information:

- Time the job started and ended
- Type of job
- Average throughput of the data
- Number of directories and files processed (backed up, restored, or copied)
- Job session number and job ID
- Result of the job
- Errors and warnings that occurred

When an integrated backup job is submitted, the scenario name is displayed in the Activity Log window, letting you monitor the progress of the job.

## Monitor Job Status Using CA XOssoft

The procedure for monitoring the replication process does not change for the integrated environment. For more information about monitoring the replication process, see the *CA XOssoft User Guide*.

You can monitor the replication process from the CA XOssoft Manager after a scenario is running. Monitoring lets you view state information, statistics, and events. The CA XOssoft Manager main window is comprised of three subordinate panes; Scenario, Framework, and Events.

The screenshot displays the CA XOssoft Manager interface with three main panes:

- Scenario Pane (1):** Shows a table of scenarios and their status.
 

Scenario	Status	Product	Server	Mode
FileServer	Running	DR/AR	FileServer	Online
MSDN Scenario	Running	DR/AR	FileServer	Online
Production Scenario 1	Running	DR/ARC	FileServer	Online
- Framework Pane (2):** Displays statistics for the selected scenario (Master 123.456.789.321).
 

Root Directory	Size	Folders Created	Changed	Removed	Renamed
C:\dev_ami	0 bytes	0	0	0	0
- Events Pane (3):** Shows a list of events.
 

ID	Severity	Host/Scenario	Time	Event
SFD0014	Significant	123.456.789.321	4/1/2008 3:48:06 PM	Starting scenario Production Scenario 1
SM00165	Significant	Production Scenario 1	4/1/2008 3:45:38 PM	Connected to 123.456.789.321

1 Scenario

2 Framework

3 Events

The Scenario pane displays each host and the corresponding status of the replication process. The replication status is reflected by one of the following icons to the left of the scenario name:

**Running** 

Indicates that the scenario replication process is running correctly.

**Stopped** 

Indicates that the scenario has been created, but the replication process has been stopped or suspended.

**Problem** 

Indicates that there is a problem with the scenario. You can click on the scenario name to display any related error messages in the Events window.

**Not Authorized** 

Indicates that incorrect or missing User Name or Password was given for the Master server.



The Framework pane displays the directories, subdirectories, and the files in those directories. The Framework pane displays two or three tabs depending upon the job status; Statistics, Directories, and Properties. The Statistics tab is only available when the replication process is running and provides information about the total amount of data for each root directory, recorded data for each Replica, and synchronization information. From a drop-down menu, you can select to view the Scenario Statistics (graphic overview of scenario status), the Master Statistics (table overview of Master Server status), or Replica Statistics (table overview of the Replica Server status).

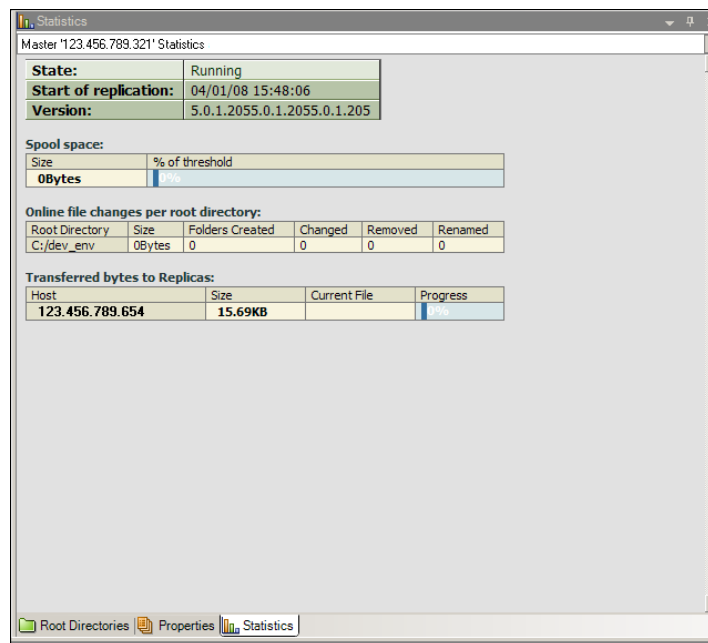
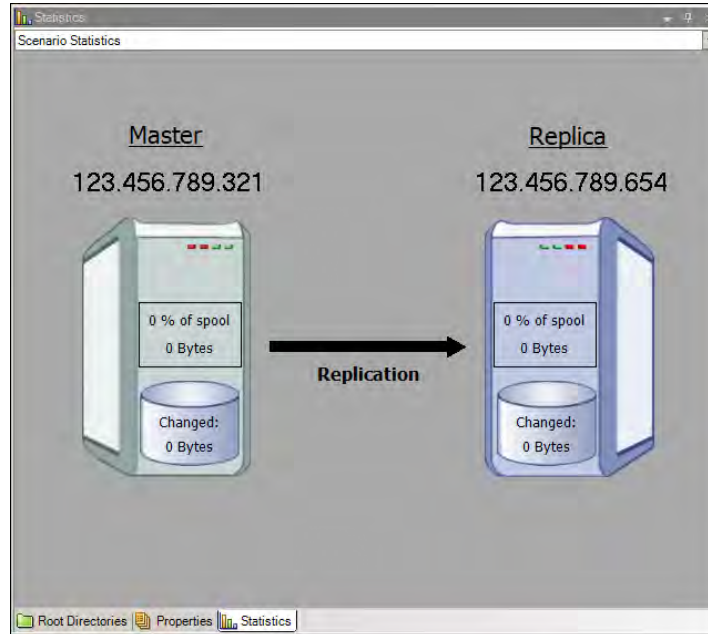

The Events pane displays messages and general information (for example, that a directory is synchronized, a server is connected, synchronization has started or finished, and so on). This information is received from the servers participating in the running replication scenario. The information in the Events pane includes the server name and time, and a brief explanation of the event. Important events or error messages are displayed in bold letters. In addition, the Events pane also displays CA ARCserve Backup status for backup jobs that are initiated through CA XOssoft.

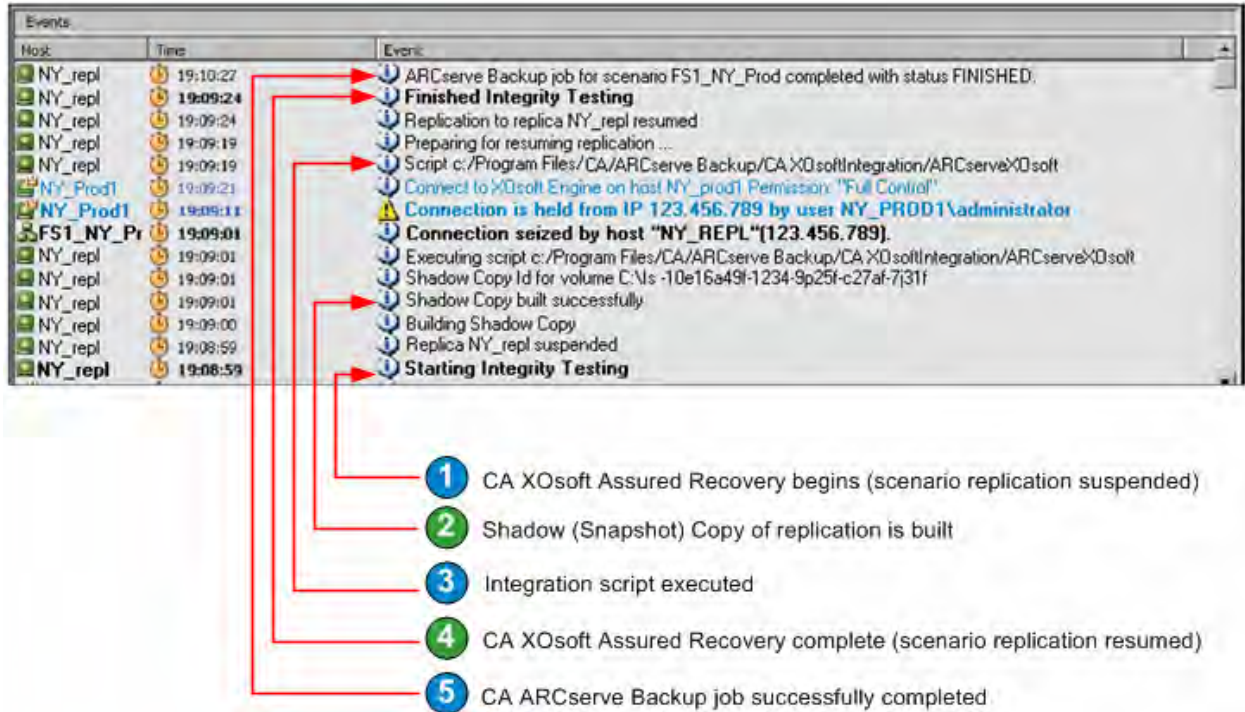

## Alert Notification

The procedure for generating and receiving alerts does not change for the integrated environment.

- For more information about generated alerts during the backup process, see the *CA ARCserve Backup Administration Guide*.
- For more information about generated alerts during the replication process, see the *CA XOssoft User Guide*.

## CA ARCserve Backup Alerts

You can use the Alert notification system to send messages about events that appear in the Activity Log during your backup operation. In addition, you can also specify the method for receiving these alert notifications. You can choose one or more of the following events for which you want to be notified:

### **Job Completed Successfully**

Indicates that all of the nodes and drives/shares were processed.

### **Job Incomplete**

Indicates that some nodes, drives, shares, or files were missed.

### **Job Canceled by User**

Indicates that the user canceled the job.

### **Job Failed**

Indicates that the job was started but could not be completed.

### **Virus Detected**

Indicates that a virus was detected in one of the files to be backed up.

### **Customized Event**

Indicates that a customized event occurred. To specify this type of event, enter an error, warning, or notification code in the space below the Event drop-down list.

## CA XOsoft Alerts

All events are reported in real time to the CA XOsoft Manager and can be integrated into the OS event logging system. The alerts can be automatically sent by email to a configured address and can also activate a notification script. Detailed real-time statistics are provided during synchronization and replication. When the event notification is configured for a scenario, the following conditions can trigger a notification:

### **Lost Connection**

Indicates that the TCP connection does not function, or a network or server went down.

### **Queue overflow**

Indicates that the quantity of data in the queue pool directory has exceeded its threshold value.

### **Other**

Indicates any other error

### **Significant info**

Indicates important information such as when synchronization is completed.

## Report Generation

The procedure for generating reports does not change for the integrated environment.

- For more information about reports during the backup process, see the *CA ARCserve Backup Administration Guide*.
- For more information about reports during the replication process, see the *CA XOsoft User Guide*.

## CA ARCserve Backup Reports

The reports generated by the CA ARCserve Backup Report Manager and CA XOssoft complement each other and provide you with a variety of reports based on the activity stored in the CA ARCserve Backup database. You can preview a report, print to a printer or file, and schedule when to generate a report. CA ARCserve Backup provides several standard reports that display general backup and restore activity and also lets you to create custom reports to meet your specific needs. You can use a report filter to select the backup media you want to include in the report.

For example, you can configure CA ARCserve Backup to automatically create and email a report for any failed backup jobs, or you can create a customized report that is generated to specifically target backup jobs that are initiated by Assured Recovery.

**Note:** For more information about reports during the backup or restore process, see the *CA ARCserve Backup Administration Guide*.

## CA XOssoft Reports

CA XOssoft can generate reports on the replication and synchronization processes. These reports can be stored on the Master, sent for display by the CA XOssoft Manager, sent by email to a specified address, or they can trigger script execution.

The CA XOssoft-generated reports include the following:

### Scenario Reports

The Scenario reports include statistics from synchronization tasks, including how much changed data was replicated. You can configure this report so that it is displayed at the end of every synchronization process.

This report helps you to verify that all processes are running properly, and helps in reviewing how much data is continually changing.

### Difference Reports

A Difference report compares the difference between the Master server and the Replica server and is generated for each replica at the end of the replication process. When a replication is suspended, all changes are spooled on the Master server until the replication is resumed. During this suspension, the Difference report displays how much data has changed. The Difference report can be produced at any time.

This report helps you determine how much data changes for a specific event.

### **Replication Report**

The Replication report includes statistics on data replicated since the beginning of the replication process, and statistics on data replicated since the last report. The data includes the number of replicated bytes, number of files created/updated/removed/and renamed, and the number of errors. You can view either a summarized or detailed report.

This helps you get an overall view of how much data is changing in the environment.

### **Synchronization Report**

Following synchronization, CA XOsoft creates and opens a report listing the files that have been transferred. This report includes the sum total of the removed and modified files, and the bytes transferred, listing all related file names, file paths, and sizes.

This report helps in monitoring and managing data change and data growth in the environment.

**Note:** For more information about reports during the replication process, see the *CA XOsoft User Guide*

# Chapter 6: Troubleshooting

---

This section contains the following topics:

[Integrated Troubleshooting](#) (see page 71)

[Error and Warning Messages](#) (see page 71)

[Integration Messages](#) (see page 72)

## Integrated Troubleshooting

When a problem is detected, CA ARCserve Backup generates a message to help you identify the problem and resolve the problem. These messages are contained in the Activity Log and can be viewed from the Job Status Activity Log tab. From the Activity Log, you can double-click an error or warning message to display the message details.

## Error and Warning Messages

Generated messages are categorized as either Error Messages or Warning Message, depending upon the severity of the resulting consequences. An Error Message is more severe and usually indicates a functionality problem that must be fixed before the job can continue. A Warning Message indicates a less severe problem that should be noted; however, the job can continue.

The generated message is formatted with some or all of the following information:

### **Message**

Indicates the Warning or Error identification number prefixed by either a W (warning) or E (error), along with a corresponding error code or brief explanation generated by CA ARCserve Backup Agent message numbers are prefixed by either an AW (agent warning) or AE (agent error).

### **Module**

Indicates the system component or area that produced the message.

### **Reason**

Describes what may have caused the message to be generated.

### **Action**

Suggests a possible resolution to the problem or a course of action you can take.

## Integration Messages

The following Error and Warning messages are associated with the integration between CA ARCserve Backup and CA XOssoft:

<b>Message Number</b>	<b>Message</b>
E3370	Unable to initialize CA XOssoft Scenario data
E3371	Unable to get session physical path
AE0457	Unable to perform AR or suspend CA XOssoft scenario
AE0458	Could not create CA XOssoft backup image
AE0459	Insufficient user credentials supplied for scenario
AE0460	Snapshot creation failed for CA XOssoft scenario
AE0461	Some snapshots could not be released for CA XOssoft scenario
AE0463	Could not attach to CA XOssoft scenario
AE0464	CA XOssoft scenario could not be stopped
AE0465	CA XOssoft scenario is not in replication state
AE0467	Backup operation not supported on CA XOssoft master or replica server
AE0468	Bad parameters for CA XOssoft scenario
AE0469	The CA XOssoft operation timed out for scenario
AE0470	CA XOssoft connection already exists for scenario
AE0471	Bad configuration for CA XOssoft scenario
AE0472	General CA XOssoft errors encountered for scenario



**Error E3370**

**Unable to initialize CA XOssoft Scenario data. (Replica=[replica host], Scenario=[CA XOssoft scenario name])**

**Module:**

Task Backup

**Reason:**

CA ARCserve Backup backend is unable to retrieve and parse the CA XOssoft scenario definition file, which is in XML format.

**Action:**

Verify that the CA ARCserve Backup engine is running.

If the problem persists, contact Technical Support at <http://ca.com/support> for online technical assistance and a complete list of locations, primary service hours, and telephone numbers.

**Error E3371**

**Unable to get session physical path. (MEDIA=[media name], ID=[media id], SESSION=[session #])**

**Module:**

Task Restore

**Reason:**

During a CA XOssoft Scenario session restore to original replica node, CA ARCserve Backup backend needs to find out the physical path of the session from the CA ARCserve Backup database. When the CA ARCserve Backup database query fails, this message is logged.

**Action:**

Verify that the CA ARCserve Backup database engine is running and without any problems.

Merge the session into the CA ARCserve Backup database.

If the problem persists, contact Technical Support at <http://ca.com/support> for online technical assistance and a complete list of locations, primary service hours, and telephone numbers.

## Error AE0457

**Unable to perform AR or suspend CA XOssoft scenario <name=[scenario name], id=[scenario id]> on replica server<[hostname]>**

**Module:**

Windows Client Agent

**Reason:**

Before backing up CA XOssoft scenario data, the Windows Client Agent asks CA XOssoft to perform Assured Recovery or suspend the scenario to take a snapshot of the scenario-replicated data. This error indicates that CA XOssoft is unable to perform the Assured Recovery suspend operation.

**Action:**

Check the CA XOssoft Manager that manages the scenario and verify that the scenario is running and is in a replication state.

Check the CA XOssoft events log to determine if there are any errors or warnings associated with the scenario.

If the problem persists, contact Technical Support at <http://ca.com/support> for online technical assistance and a complete list of locations, primary service hours, and telephone numbers.

## Error AE0458

**Could not create CA XOssoft backup image <name=[scenario name], id=[scenario id]> on replica server<[hostname]>.**

**Module:**

Windows Client Agent

**Reason:**

This is a generic CA XOssoft backup error message. It could be related to insufficient system resources or XOssoft engine problems.

**Action:**

Check the system event log to determine if there are any system-related problems.

Check the CA XOssoft events log to determine if there are problems related to the CA XOssoft scenario.

If the problem persists, contact Technical Support at <http://ca.com/support> for online technical assistance and a complete list of locations, primary service hours, and telephone numbers.

**Error AE0459**

**Insufficient user credentials supplied for scenario <name=[scenario name], id=[scenario id]>, unable to login to CA XOssoft on master server<[hostname]>.**

**Module:**

Windows Client Agent

**Reason:**

When creating a CA XOssoft scenario backup job, you are required to provide the scenario Master server user credential, which will be packaged into the job script. This error indicates that the username or password is not correct or does not have administrative privilege.

**Action:**

Verify that the Master server user credential is correct. If the user is a domain user, the domain name and user name must be in the format of DomainName\UserName.

Verify that the user has administrative privilege of the master node. Check the administrators group of the Master server to determine if the user is part of that group. If it is not, you must add the user to the group.

If the problem persists, contact Technical Support at <http://ca.com/support> for online technical assistance and a complete list of locations, primary service hours, and telephone numbers.

## Error AE0460

**Snapshot creation failed for CA XOsoft scenario <name=[scenario name], id=[scenario id]> on replica server<[hostname]>.**

**Module:**

Windows Client Agent

**Reason:**

Before backing up CA XOsoft scenario replication data, the XOsoft engine will take a snapshot of the replication data and the CA ARCserve Backup agent will backup the data from the snapshot. This error indicates that the XOsoft engine is unable to create the snapshot and is most likely caused by insufficient system resources, such as not enough disk space.

**Action:**

Verify that the disk used to hold the snapshot still has enough free space.

Check the system event log for VSS-related errors.

Verify that the XOsoft engine service is running.

If the problem persists, contact Technical Support at <http://ca.com/support> for online technical assistance and a complete list of locations, primary service hours, and telephone numbers.

## Error AE0461

**Some snapshots could not be released for CA XOsoft scenario <name=[scenario name], id=[scenario id]> on replica server<[hostname]>.**

**Module:**

Windows Client Agent

**Reason:**

After the scenario backup is done, the XOsoft engine tries to release the snapshot created earlier. This error indicates possible insufficient system resources.

**Action:**

Check the system event log to see if there are any system-related errors.

Verify that the XOsoft engine service is running.

If the problem persists, contact Technical Support at <http://ca.com/support> for online technical assistance and a complete list of locations, primary service hours, and telephone numbers.

**Error AE0463**

**Could not attach to CA XOsoft scenario <name=[scenario name], id=[scenario id]>.**

**Module:**

Windows Client Agent

**Reason:**

The CA ARCserve Backup agent cannot communicate with the XOsoft engine service. This problem could be caused by one of the following reasons:

- The XOsoft engine service is not running on the Replica or Master server.
- There is a network connection problem.
- The COM object AS\_ws\_backup\_c is not registered.

**Action:**

To address this message, perform the following tasks:

- Verify that the XOsoft engine service is running on both the Replica and Master server.
- Ping the Master and Replica servers to verify that there is no network connection problem.
- Use Oleview.exe or other tools to confirm that COM object AS\_ws\_backup\_c is registered on the CA ARCserve Backup agent machine.
- If the problem persists, contact Technical Support at <http://ca.com/support> for online technical assistance and a complete list of locations, primary service hours, and telephone numbers.

## Error AE0464

**CA XOsoft scenario <name=[scenario name], id=[scenario id]> could not be stopped. Please manually stop the scenario and retry restore.**

**Module:**

Windows Client Agent

**Reason:**

Before restoring the CA XOsoft-replicated data, the CA ARCserve Backup agent asks the XOsoft engine to stop the running scenario. This error indicates that the XOsoft engine service may not be running or that the user credential for the Master server is incorrect.

**Action:**

To address this message, perform the following tasks:

- Verify that the XOsoft engine service is running on both the Replica and Master servers.
- Verify that the Master server user credential in the job script is correct. If the domain user is used, the user name must be in DomainName\UserName format.
- Check the "Continue the restore job even when the scenario cannot be stopped" check box option (on the Restore Manager Global Options Operation dialog), and try to perform the restore job again.
- If the problem persists, contact Technical Support at <http://ca.com/support> for online technical assistance and a complete list of locations, primary service hours, and telephone numbers.

**Error AE0465**

**CA XOsoft scenario <name=[scenario name], id=[scenario id]> is not in replication state. Please retry backup when the scenario is in replication state.**

**Module:**

Windows Client Agent

**Reason:**

This error indicates that during a backup, the scenario is not in a replication state.

**Action:**

Check the CA XOsoft manager to verify that the scenario is in a replication state. If it is not, wait until it is in replication state and run the job again after scenario is in a replication state.

If the problem persists, contact Technical Support at <http://ca.com/support> for online technical assistance and a complete list of locations, primary service hours, and telephone numbers.

**Error AE0467**

**Backup operation not supported on CA XOsoft master <[hostname]> or replica<[hostname]> server. Please refer to product documentation for supported configuration.**

**Module:**

Windows Client Agent

**Reason:**

The XOsoft engine on the Replica server cannot initialize the scenario for the backup due to an invalid master or replica host name or the host name resolution does not work.

**Action:**

If the host name was changed since the scenario was created, verify that node name of the scenario's Master and Replica server is still correct.

Verify that the DNS name resolution is working in the Replica host.

If the problem persists, contact Technical Support at <http://ca.com/support> for online technical assistance and a complete list of locations, primary service hours, and telephone numbers.

## Error AE0468

**Bad parameters for CA XOssoft scenario <name=[scenario name], id=[scenario id]>.**

**Module:**

Windows Client Agent

**Reason:**

This is a CA ARCserve Backup internal error. This message indicates that an incorrect parameter was passed to the CA XOssoft API.

**Action:**

Collect the CA ARCserve Backup server and agent log files and contact Technical Support for assistance.

For online technical assistance and a complete list of locations, primary service hours, and telephone numbers, contact Technical Support at <http://ca.com/support>.



**Error AE0469**

**The CA XOssoft operation timed out for scenario <name=[scenario name], id=[scenario id]>.**

**Module:**

Windows Client Agent

**Reason:**

The CA XOssoft operation cannot be completed within the time interval specified. The default timeout value is three minutes.

**Action:**

To address this message, perform the following tasks:

- Check the Master and Replica servers to verify that the XOssoft engine service is running.
- Check the CA XOssoft Manager to verify that the scenario is running and check the CA XOssoft events log for any errors related to the scenario.
- Increase the timeout value by accessing the CA ARCserve Backup Client Agent registry tree and specifying the CAXOssoftTimeout DWORD to a value greater than 180 seconds, as follows:

```
\\HKEY_LOCAL_MACHINE\SOFTWARE\Computer Associates\CA ARCserve  
Backup\ClientAgent\Parameters\CAXOssoftTimeout
```

If the problem persists, contact Technical Support at <http://ca.com/support> for online technical assistance and a complete list of locations, primary service hours, and telephone numbers.

#### Error AE0470

**CA XOsoft connection already exists for scenario <name=[scenario name], id=[scenario id]>. Please retry backup.**

**Module:**

Windows Client Agent

**Reason:**

This message indicates that there is another backup job being backed up and the scenario or some other applications have the connection to the scenario.

**Action:**

Wait and retry the backup job.

If the problem persists, contact Technical Support at <http://ca.com/support> for online technical assistance and a complete list of locations, primary service hours, and telephone numbers.

#### Error AE0471

**Bad configuration for CA XOsoft scenario <name=[scenario name], id=[scenario id]>. Please ensure that you either have Assured Recover (AR) configured or Suspend enabled for this scenario.**

**Module:**

Windows Client Agent

**Reason:**

This message indicates that the CA XOsoft scenario may be incorrectly configured.

**Action:**

See the *CA XOsoft User Guide* for detailed information about configuring scenarios.

If the problem persists, contact Technical Support at <http://ca.com/support> for online technical assistance and a complete list of locations, primary service hours, and telephone numbers.

Error AE0472

**General CA XOssoft errors encountered for scenario <name=[Scenario Name], id=[Scenario ID]>. Please check CA XOssoft logs for more information.**

**Module:**

Windows Client Agent

**Reason:**

This message indicates that the CA XOssoft API encountered some unclassified errors and the CA ARCserve Backup agent will enter this message into its log.

**Action:**

Check the CA XOssoft Manager for more detailed information related to scenarios.

If the problem persists, contact Technical Support at <http://ca.com/support> for online technical assistance and a complete list of locations, primary service hours, and telephone numbers.



# Index

---

## A

Activity Log Monitoring • 62

Alerts

CA ARCserve Backup Alerts • 67

CA XOssoft Alerts • 68

## B

Backup Process

Create and Run a Backup Job • 38

How the Backup Process Works • 10

Job Queue Monitoring • 62

Monitoring Job Status Using CA ARCserve Backup • 61

Run a Scenario • 36

Bare-Metal Recovery • 24

Benefits • 11

## C

CA ARCserve Backup

Alerts • 67

Create and Run a Backup Job • 38

Description • 8

Monitoring Job Status Using CA ARCserve Backup • 61

Reports • 69

Restore Using CA ARCserve Backup

Restore by Query • 58

Restore by Session • 48

Restore by Tree • 55

Restore Exchange Scenario to Master Server • 60

CA XOssoft

Alerts • 68

CA XOssoft Alerts • 68

Description • 9

Monitoring Job Status Using CA XOssoft • 63

Reports • 69

Restore Using CA XOssoft via Data Rewind • 46

Restore Using CA XOssoft via Failover • 46

Run a Scenario • 36

Capabilities • 11

CDC • 12

CDP • 13

Central Data Center • 12

Configuration Requirements

BrightStor ARCserve Backup Server on Replica Server • 26

Standalone BrightStor ARCserve Backup Server • 25

contacting technical support • iv

Continuous Data Protection • 13

Create and Run a Backup Job • 38

customer support, contacting • iv

## D

Data Rewind

Definition • 13

Restore Using CA XOssoft via Data Rewind • 46

Definitions • 13

## E

Entity • 13

Error and Warning Messages • 71

## F

Failover

Definition • 13

Restore Using CA XOssoft via Failover • 46

## J

Job Queue Monitoring • 62

## M

Master Server • 13

Monitoring

Activity Log Monitoring • 62

CA ARCserve Backup Alerts • 67

CA XOssoft Alerts • 68

Job Queue Monitoring • 62

Monitoring Job Status Using CA ARCserve Backup • 61

Monitoring Job Status Using CA XOssoft • 63

## R

RBO • 12

Remote Branch Office • 12

Replica Server • 13

---

Replication • 13

Reports

CA ARCserve Backup Reports • 69

CA XOssoft Reports • 69

Restore

How the Restore Process Works • 20

Restore by Query • 58

Restore by Session • 48

Restore by Tree • 55

Restore Exchange Scenario to Master  
Server • 60

Restore Using CA XOssoft via Data Rewind •  
46

Restore Using CA XOssoft via Failover • 46

Rewind Point • 13

Run a Scenario • 36

## S

Scenario • 13

support, contacting • iv

Synchronization • 13

## T

technical support, contacting • iv

Terms • 13

Troubleshooting

Error and Warning Messages • 71

Introduction • 71